

SPECIFICATIONS

MODEL	9506-2200	9600-2200
VOLTAGE	220	220
FREQUENCY	50	50
HORSEPOWER	1/2	1/2
RPM	1725	1725
WEIGHT (LBS)	35	55
DIMENSIONS	10"H 18"W 8 1/2"D	12"H 23"W 11 1/2"D



9506-2200
9600-2200

WILS-AWAY ELECTRIC TUBE CLEANER

TROUBLE-SHOOTING

PROBLEM	CAUSE & SOLUTION
No power or Main Switch not lit up when unit is plugged into power outlet	Power is not on —flip Main switch to ON position GFCI Plug not reset —press reset button on GFCI GFCI Plug defective Main switch defective
Main Switch lit up but motor not turning when activated	Leakage in air-activated switch system —defective Foot Pedal —defective air switches Defective motor Short-circuit of wiring
Main Switch lit up & motor hums or runs only in reverse when activated.	Defective air switches —replace air switch
Motor running but Flexible Shaft not turning	Broken Safety Coupling
Motor running but no water output at end of Flexible Shaft	Water supply not turn on Defective Solenoid Valve
Motor running and water drips inside unit	—Worn Teflon seal inside Motor Connector —Leakage in tube or tube fittings
Unit running rough and/or noisy	Lack of lubrication in Motor Connector —grease ball bearings inside Motor Connector through grease fitting through access hole in bottom of unit —replace worn or corroded ball bearings in Motor Connector



OPERATING INSTRUCTIONS & SERVICE MANUAL

Rev: A, 1/20/2015

TO REDUCE THE RISK OF INJURY AND EQUIPMENT DAMAGE
USER MUST READ AND UNDERSTAND OPERATOR'S MANUAL.

Thomas C. Wilson, LLC

21-11 44th Avenue, Long Island City, New York 11101
Tel: (800) 230-2636 Fax: (718)361-2872 <http://www.tcwilson.com>
E-mail: tcwilson@tcwilson.com

Thomas C. Wilson, LLC

21-11 44th Avenue, Long Island City, New York 11101
Tel: (800) 230-2636 Fax: (718)361-2872 <http://www.tcwilson.com>
E-mail: tcwilson@tcwilson.com



SAFETY INSTRUCTIONS





WARNING!

READ AND UNDERSTAND ALL INSTRUCTIONS
 Failure to follow all instructions listed below, may result in accident, fire and/or personal injury.

SAVE THESE INSTRUCTIONS

1. **KNOW YOUR POWER TOOL.** Read this service manual carefully.

2.  **WEAR PROPEL APPAREL.** No loose clothing or jewelry to get caught in mov-ing parts. Rubber gloves and footwear are recommended when working outdoors.

3.  **WEAR EAR PROTECTION.** Operator must wear ear protection and safety glasses. Also face or dust mask if cutting operation is dusty.

4.  **WEAR STEEL TOE PROTECTIVE SHOES.** Operator must wear steel toe shoes during operation and transpotation.

5.  Do not operate this machine on high ground or on a slope.

Product Use Criteria

- Normal conditions: Operate at temperatures up to 250°F (121°C).
- Hazardous conditions: Operate at temperatures up to 104°F (40°C).
- Protect unit from dirt and moisture.
- Use **ONLY** compressed air to drive motor.
- Air lines connected to motor should be the same size or the next size larger than the inlet port for efficient output and speed control.
- Protect all surrounding items from exhaust air.
- Bearings are grease packed.
- Use Gast #AD220 or a detergent SAE#10 automotive engine oil for lubricating.
- Motors are to be used in commercial installations only.
- **This motors is not designed for use in hazardous atmospheres.**
- Air supply, directional control valve and pressure regulator should be selected based upon the air consumption of the motor.

Your safety and the safety of others is extremely important.

We have provided many important safety messages in this manual and on your product. Always read and obey all safety messages.

 This is the safety alert symbol. This symbol alerts you to hazards that can kill or hurt you and others. The safety alert symbol and the words "DANGER" and "WARNING" will precede all safety messages. These words mean:

 **DANGER**

You will be killed or seriously injured if you don't follow instructions.

 **WARNING**

You can be killed or seriously injured if you don't follow instructions.

All safety messages will identify the hazard, tell you how to reduce the chance of injury, and tell you what can happen if the safety instructions are not followed.

Improper environment, installation and operation can result in severe personal injury and/or damage to property.

Qualified personnel must perform all work to assemble, install, operate, maintain and repair air motor.

Qualified personnel must follow:

- These instructions and the warning and information labels on the motor.
- All other drive configuration documents, startup instructions and circuit diagrams.
- The system specific legal regulations and requirements.
- The current applicable national and regional specifications regarding explosion protection, safety and accident prevention.

MAINTENANCE

- Note: Remove the plug from the power outlet before carrying out any adjustment service or maintenance.
- Safety coupling replacement: A 80 in-lb Safety Coupling (#9600-0102) is supplied within the motor connection assembly as standard (Kit includes a spare). This will break if the shaft is overloaded by forcing cleaning tool within the tube. A hook type removal tool (#9600-0055) is supplied for removing this broken unit. Engage the far end of the broken coupling with this tool and pull the coupling out.
- Storage: To store, disconnect water supply hose and foot pedal. Disconnect flexible shaft from machine. Dry out the shaft with an air blast through a hose fitting (optional #9614) attached to large aluminum coupling. Store the tube cleaner in a dry, heated place.
- Lubrication: Periodically, grease ball bearing inside motor connector housing through grease fitting, usually every 200 hours of services.
- Replacement of cords or electrical components: If supply cord is damaged, it must be replaced by a special cord or assembly available from the factory. available from the factory

LIST OF ACCESSORIES

- Single Foot Pedal #9600-0059
- Dual Foot Pedal #9600-0015
- Dolly #9600-0134
- Shaft Lubricator #9675-0000
- Safety Coupling & Remove Tool #9600-0136
- Flexible Shaft & Casing #9720-00xx, #9722-00xx, #9724-00xx, #9726-00xx
- Expanding Brushes #9900-x00x, #7000-x00x, #2456-x00x, #2463-x00x (Max. Speed = 1725/min.)
- Spiral Brushes #61746-x0xx, #62501-x0xx (Max. Speed = 1725/min.)

EXPLANATION OF SYMBOLS USED:

- n_o-----rated no load speed
- V-----volts
- A-----amperes
- Hz-----hertz
- W-----watts
- kW-----kilowatts
- /min.-----revolutions per minute

- ~-----alternate current
- ⊕-----ground terminal
- I-----power on
- O-----power off

ASSEMBLY

The WILS-AWAY Tube Cleaner may be set up with its built-in dolly for operator convenience. Follow the assembly instructions below:

1. Set the WILS-AWAY on its end with aluminum Motor Connector facing up. Insert the Dolly Handle through square hollow brackets.
2. Insert Clevis Pins through lower hole on both sides.
3. Pull Handle up until it stops and insert the Quick-Release Pin through the bracket and the upper hole of Handle on both sides.
4. Insert Axle through bracket at bottom. Mount wheel onto Axle on both sides.
5. Tighten Stop Nuts with a wrench to secure the wheels. Tighten just enough so that the wheel will spin freely.

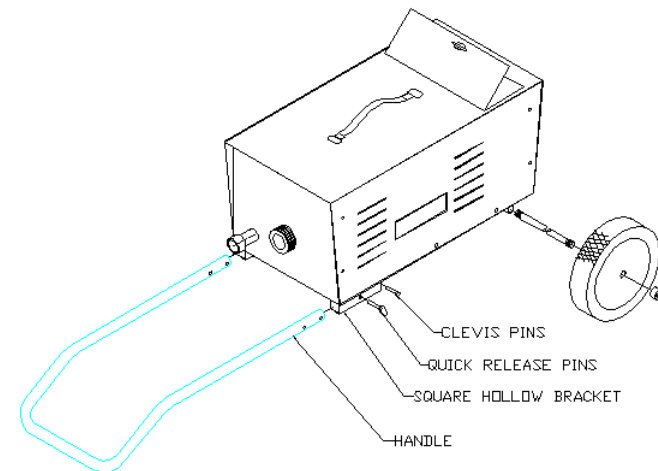

OPERATING POSITION

The WILS-AWAY tube cleaner may be operated with or without the dolly in place. However, it should be only with the top side (side with carrying handle) up, as illustrated below:

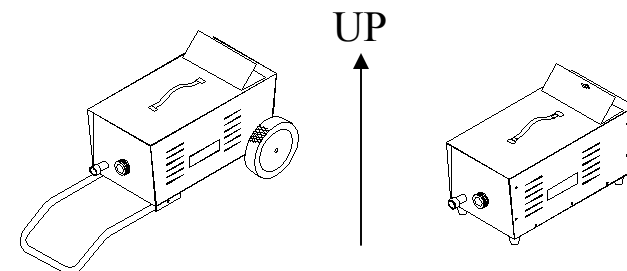

OPERATION

1. Remove electrical cord from storage compartment and plug it in a properly grounded outlet. Press the reset button on the GFCI plug.



2. Flip the main switch on the side panel. The pilot light should go on indicating power is on.



3. Remove foot pedal from box and connect its tube end to air spout on side panel. For single direction applications, connect tube to air spout marked FORWARD (clockwise rotation viewing from back of machine). For bi-direction applications, connect tubes to air spouts according to labels attached. NOTE: Remote air switches operate at alternate action (step on/step off) in FORWARD mode and at momentary action in REVERSE mode.



4. Select flexible Shaft as required for tube size to be cleaned. Uncoil and stretch out to straighten it as much as possible. Pull male Square extending from large aluminum coupling out about an inch. Insert this square into coupling within motor connection on box end. Box may be set on opposite end to facilitate this. Securely hand-tighten large aluminum coupling with seal quad-ring captive within onto motor connector assembly.

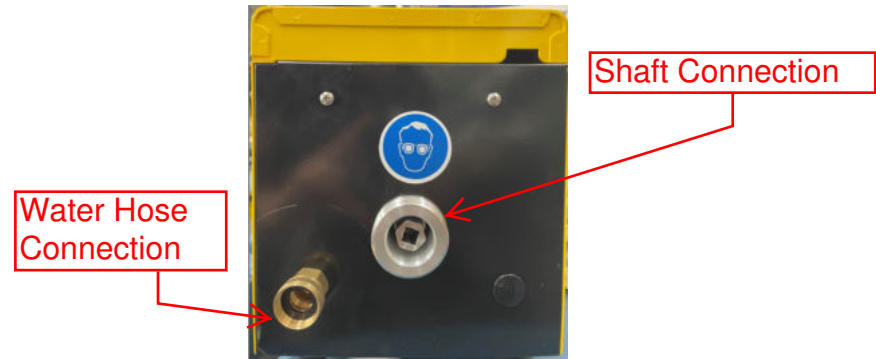

5. Connect water hose to water inlet with strainer within. Turn water supply on. Solenoid valve only opens to allow water through when the motor is running.
6. Position hose clamp or place a mark on outside of flexible shaft to retain brush or cleaning head just within tube on opposite end.
7. Place the foot pedal at a point close to the tube sheet. Hold the end of the flexible shaft with one hand about three inches from the cleaning head; making sure it is held away from your body and then depress the foot pedal.
8. The electric motor will operate and drive the flexible shaft, which in turn rotate the cleaning head. At the same time, water will pass through the machine and out at the end of the casing near the cleaning head.
9. Feed the shaft with cleaning head through tube to clean and loosen deposits inside tube.
10. Place a bucket in front of the tube to collect water. Wear non-slippery work boot to avoid slipping on wet ground surface.
11. For bi-direction applications involving internally-spiraled tubes, use spiral brushes only. These spiral brushes have a jam nut on shank to retain itself in shaft during operation. An optional dual foot pedal (#9600-0015) is required for this application.
12. Observe the following operation guidelines:
 - Only feed uncoiled flexible shaft into tube.
 - Do not force cleaning head within tube. If any resistance is felt, back off two inches or so and re-feed shaft until it moves easily through the tube. If this fails, use a smaller cleaning head or one intended for plugged tube application.
 - Keep bends in shaft minimal and avoid sharp 'S' bend.
 - Do not allow tools to come out of other end of tube.