

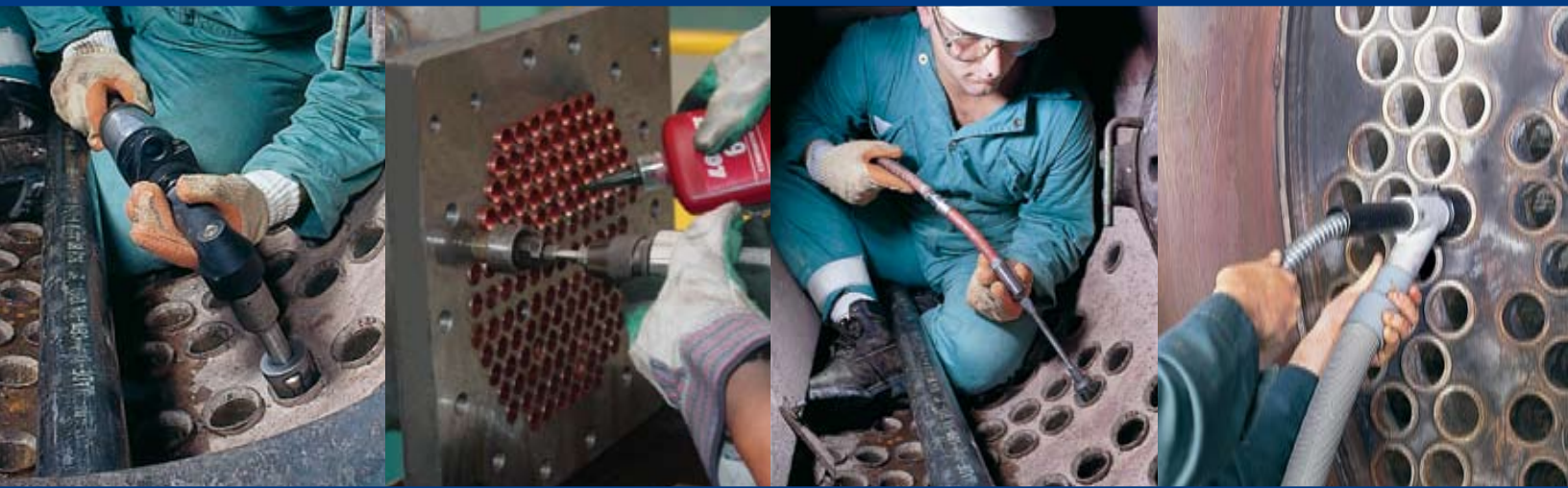

*Smarter Tools for  
Smarter Work*

## A Quick Reference to Find and Order Your Wilson Tools



Tools for the maintenance and  
repair of...

**BOILERS**

**CONDENSERS**

**HEAT EXCHANGERS**

**EVAPORATORS**

**CHILLERS/ABSORBERS**

**COOLERS**

**Thomas C. Wilson, Inc.**

## Thomas C. Wilson, Inc.

### Wilson...

#### A Family Tradition

Thomas C. Wilson, Inc. was founded by my grandfather in 1925. The company originally developed a line of air, water, and electrically driven tube cleaners which, with improvements from time to time to keep abreast of advances in metallurgy and tubular apparatus design, remains unsurpassed to the present day. These tools and other Wilson tools and accessories are now sold to the process, power, HVAC, OEM manufacturer, boiler repair, and commercial markets, both domestically and abroad.

Our engineering department is continually updating our current products and developing new ones to help increase the efficiency of those working to build, repair, and maintain heat exchangers, boilers, condensers, chillers/absorbers, and similar pressure vessel products.

Our success through the years has been a direct result of our commitment to outstanding customer service. From our service hotline to our money back guarantee, we are committed to ensuring not only the quality of our products, but also the complete satisfaction of you, our customer.

Sincerely,



Stephen Hanley  
Chief Operating  
Officer & President



#### Service Hotline

If you have technical questions about tube cleaning and expanding, or any Thomas C. Wilson, Inc. product, call us toll free at (800) 230-2636 and talk to a knowledgeable Thomas C. Wilson, Inc. representative.

**There is a Thomas C. Wilson, Inc. representative or distributor in every major city, domestically and internationally. Please write, call, or fax us to locate your area representative.**



#### Customer Satisfaction/Money Back Guarantee

If, for any reason, you are not satisfied with your purchase, simply return it to us within 10 days, and we will refund the purchase price of the unit, exclusive of shipping and handling costs.



#### One Year Limited Warranty

All Thomas C. Wilson, Inc. products are manufactured, tested, and inspected in accordance with strict engineering requirements and are warranted to be free from defects in materials and workmanship.\*



#### Delivery

Thomas C. Wilson, Inc. products are delivered by all major common carriers, and next day delivery is available. We also have same day, counter-to-counter delivery on request.



#### What's On Your Mind

We're always interested in your comments! At Thomas C. Wilson Inc., we work every day to improve our product offerings and customer service. We want to know what you think. Please write, call, or fax us with your comments or suggestions, or reach us online at <http://www.tcwilson.com>.

#### THOMAS C. WILSON, INC. MAIN FACILITY:

21-11 44th Avenue • Long Island City, NY 11101-5088 USA

(800) 230-2636 • (718) 729-3360

fax: (718) 361-2872 • e-mail: [tcwilson@tcwilson.com](mailto:tcwilson@tcwilson.com).



### How to Order



Our sales engineers are available Monday - Friday, 8:30am to 6:30pm EST. The easiest way to order is to look up the product that you would like to purchase and note the corresponding part number. Then, call toll free (800) 230-2636. If you are not sure exactly what tool you need, just give our experienced staff the details and they will help you find the right product for your application.

**You can use your Visa, Mastercard, or American Express card to order.**

\* There is a minimum order of \$50.

All Thomas C. Wilson, Inc. products are designed and manufactured in the U.S.A.

\* The warranty is subject to conditions and limitations. Call for details.

24 HOUR SERVICE  
365 days a year...Call

**1-800-230-2636**



# Smart Tube Cleaning

	<p><b>Spiral Brushes</b> 1/4 to 4-Inch ID Tubes in Heat Exchangers, Condensers, Chillers, Absorbers, Fire Tube and Water Tube Boilers</p>	<p><b>Removes Light to Medium Debris</b> Available in nylon, brass, steel and stainless steel. Always match metals, using bronze for nonferrous tubes and steel for ferrous metals. Nylon brushes can be used with all tubes and will not damage the interior tube wall!</p>	<p><b>Wils-Away™</b> Electric and Pneumatic Tube Cleaning Systems</p>
	<p><b>Specialty Brushes</b> 1/2 to 1-Inch ID Tubes in Surface Condensers and Enhanced Tubes in Heat Exchangers</p>	<p><b>Cleans Enhanced and Surface Condenser Tubes</b> <b>Spin Grit Brushes</b> feature silicone carbide-impregnated long bristles that lay over to clean prime surfaces in condenser tubes. <b>Spin Clean Brushes</b> use tapered trim, abrasive-impregnated brushes to clean enhanced tubes in heat exchangers.</p>	<p><b>ALL Wilson</b> Electric and Pneumatic Tube Cleaning Systems</p>
	<p><b>Expanding Brushes</b> 1/2 to 6-Inch ID Tubes in Heat Exchangers, Condensers, Chillers, Absorbers, Fire Tube and Water Tube Boilers</p>	<p><b>Removes Soft to Powdery Deposits</b> The BEST value in tube cleaning, the <b>Wilson Expanding Brush</b> lasts at least 10 times longer than fixed diameter brushes, and refills keep the <b>Expanding Brush</b> both durable and economical. Available with nylon, bronze, steel or stainless steel bristles</p>	<p><b>ALL Wilson</b> Electric and Pneumatic Tube Cleaning Systems</p>
	<p><b>Wheel Brushes</b> 1/2 to 3/4-Inch ID Tubes in Heat Exchangers, Condensers, Chillers, Absorbers, Fire Tube and Water Tube Boilers</p>	<p><b>Also Removes Soft to Powdery Deposits</b> Wheel brushes attach to both Wilson and competing drive units, and they remove thin to medium deposits. The <b>Straight Wheel Brush</b> is designed for straight tubes, such as those in Fire Tube Boilers, while the <b>Curved Wheel Brush</b> cleans curved tubes.</p>	<p><b>ALL Wilson</b> Tube Cleaning Systems (and competing drive units)</p>
	<p><b>Expanding Scrapers</b> 1/2 to 6-Inch ID Tubes in Heat Exchangers, Condensers, Chillers, Absorbers, Fire Tube and Water Tube Boilers</p>	<p><b>Removes Wet and Gummy Deposits</b> Centrifugal force lifts scraper blades, forcing them against tube interior and adjusting automatically for changes in tube ID. Scraper refills prolong the life of this cleaning head and keep it very economical.</p>	<p><b>ALL Wilson</b> Electric and Pneumatic Tube Cleaning Systems</p>
	<p><b>Buffing Tools</b> 3/8 to 3-Inch ID Tubes in Heat Exchangers, Condensers, Chillers, Absorbers, Fire Tube and Water Tube Boilers</p>	<p><b>Removes Light to Medium Scale</b> The <b>Buffing Tool</b> is available with a unique Drill Tip that cuts through heavier deposits. Also use the <b>Buffing Tool</b> to finish tubes after initial cleaning by <b>Wilson Cutter Heads, Drill Heads or Cutter Bits</b>.</p>	<p><b>ALL Wilson</b> Tube Cleaning Systems (and competing drive units)</p>
	<p><b>Small Cutter Heads</b> 1/2 to 2-Inch ID Straight or Curved Tubes in Heat Exchangers, Condensers, Chillers and Water Tube Boilers</p>	<p><b>Removes Thin to Medium Soft or Hard Scale</b> <b>Model A Cutter Head</b> attaches directly to motor. <b>Model B Cutter Head</b> attaches to <b>Type C Flexible Holder</b> for curved tube cleaning. All <b>Cutter Heads</b> feature non-tracking design for more effective cleaning.</p>	<p><b>ALL Wilson</b> Tube Cleaning Systems</p>
	<p><b>Large Cutter Heads</b> 1½ to 22-Inch ID Tubes in Boilers, Power Plants, Refineries and Other Industrial Applications</p>	<p><b>Removes Heavy, Hard Deposits</b> <b>Model SE:</b> Straight or curved tubes to 6-Inch ID <b>Model R:</b> Straight tubes to 11½-Inch ID <b>Model CHJ:</b> Straight or curved tubes to 22-Inch ID <b>Swing Frame Brush:</b> Straight pipes to 20½-Inch ID</p>	<p><b>Wilson</b> Air Motors</p>
	<p><b>Drill Heads</b> 2 to 6-Inch ID Tubes in Fire Tube and Water Tube Boilers, and Other Large Diameter Pressure Vessels</p>	<p><b>Cleans Totally Clogged Tubes/Hard Scale</b> Literally drills through clogged tubes and heaviest scale and coke. Can be used to clean curved tubes by mounting the <b>Drill Head</b> on a <b>Universal Joint</b> or <b>Flexible Holder</b>.</p>	<p><b>ALL Wilson</b> Tube Cleaning Systems</p>
	<p><b>Cutter Bits</b> 3/8 to 2¾-Inch ID Tubes in Heat Exchangers, Condensers, Chillers, Refineries, Pulp and Paper Plants and Other Industrial Applications</p>	<p><b>Cuts Through Hard Scale/Plugged Tubes</b> <b>M Bit:</b> Affordable, general purpose removal of hard scale <b>SPE-DUR Bit:</b> Excellent for plugged tubes <b>K Bit:</b> Features carbide tip that will break through hardest scale and deposits</p>	<p><b>PG/PGX-2/TP-302</b> and other <b>Wilson</b> Tube Cleaning Systems</p>
	<p><b>P Brushes</b> 3/8 to 2¾-Inch ID Tubes in Heat Exchangers, Condensers, Chillers, Evaporators and Other Industrial Pressure Vessels</p>	<p><b>Post Cutter Bit Finishing/Push Rod Cleaning</b> <b>P Brush</b> is used for finishing up after a <b>Cutter Bit</b> has been used to remove hard or heavy scale or deposit. The <b>P Brush</b> is also used with Push Rod for manual cleaning of Condensers, Evaporators and Fire Tube Boilers.</p>	<p><b>PG/PGX-2/TP-302</b> and other <b>Wilson</b> Tube Cleaning Systems</p>

# Heat Exchangers/Condensers

## Wils-Matic™ Auto Tube Puncher



### Applications

- Cleaning Straight Tubes in Heat Exchangers, Condensers, Chillers, Absorbers, Water Heaters, Coolers and Other Small Diameter Pressure Vessels
- 1/2 – 1 1/4-Inch (15.9 to 31.8 mm) Outer Diameter Tubes
- Removing Light to Medium Soft Deposits

### Specifications

- Dolly Mounted
- Drive Unit: 85 lbs.; 42" H x 30" W x 16" D (38kg, 1067 x 762 x 406 mm) (excluding Gun Assembly and Shaft)
- Shaft Speed 1,725 rpm
- Shaft Feed Rate 4.2 feet (1.3M) per second
- Feed Force 60 lbs. (267N)
- Motor Power 1 HP (0.75kW)
- Input Power 15 amps
- Voltage/Frequency 115 volt 60 Hz (220 volt 50/60 Hz available)

### Wils-Matic Kit Includes

- Electronic Drive Unit with portable dolly
- Feeder Gun Assembly
- Feeder Gun Safety Harness
- Shaft & Casing - 45 feet
- Shaft Length Stop unit
- Service Manual SM-165

Patent Pending

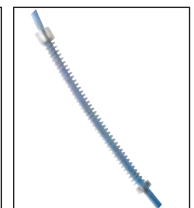

Tube ID Range		Complete Kit*	consists of	Drive Unit	and	Flexible Shaft & Casing†	and	Feeder Gun Assembly & Safety Harness	and	Shaft Length Stop Unit
Inches	(mm)									
.437 - .499	(11.1 - 12.7)	WAM-5500-375		9992-1600		9722-0045 (1/4 x 28 Female Thread)		9992-3105 & 9992-3150		9992-4030
.500 - .561	(12.7 - 14.2)									
.562 - .624	(14.2 - 15.8)									
.625 - .686	(15.9 - 17.4)	WAM-5500-500		9992-1600		9724-0045 (1/4 x 28 Female Thread)		9992-3105 & 9992-3150		9992-4000
.687 - .749	(17.4 - 19.0)									
.750 - .811	(19.0 - 20.6)									
.812 - .874	(20.6 - 22.2)									
.875 - .936	(22.2 - 23.8)									
.937 - .999	(23.8 - 25.4)									
1.000 - 1.061	(25.4 - 26.9)									

Product Details:

Page 21

\* For 220V 50/60Hz units, order WAM-5520-375 and WAM-5520-500  
 † Longer length available (see page 31)

# Wils-Matic™ Auto Tube Puncher



### Smart Tool

- Simultaneous hand-controlled activation of motor direction, shaft feed, and water flushing enable one-man operation
- Unique “non-slip” feeding
- Adjustable forward end limit stop
- Quick “plug & play” start up



### How it works

During operation, a feeder gun controls shaft rotation, shaft feed, and the water flow. By just pressing the top of the trigger, you will rotate the shaft clockwise, start water flow, and feed the Shaft & Casing into the tube. By pressing the bottom of the trigger, you will reverse the shaft rotation and pull out the Shaft & Casing from the inside of the tube. The distance to be cleaned is set by an adjustable Shaft & Casing length stop unit, and the shaft feed stops when it reaches the set distance.



Nylon Spiral Brushes	Brush Diameter	
	Inches	(mm)
62501-4043	7/16	(11.1)
62501-4050	1/2	(12.7)
62501-4056	9/16	(14.3)
62501-4062	5/8	(15.9)
62501-4068	11/16	(17.5)
62501-4075	3/4	(19.1)
62501-4081	13/16	(20.6)
62501-4087	7/8	(22.2)
62501-4093	15/16	(23.8)
62501-4100	1	(25.4)

Page 20



Spin Grit Brush	Brush Diameter	
	Inches	(mm)
62551-0062	5/8	(15.9)
62551-0075	3/4	(19.1)
62551-0100	1	(25.4)
62551-0125	1 1/8	(28.6)

Page 20



Spin Clean Brush	Brush Diameter	
	Small	Large
62615-0075	.500	.750
62615-0100	.625	1.000
62615-0112	.750	1.125
62615-0175	1.000	1.375

Page 20



## Wils-Away™ Electric Tube Cleaning System



### Applications

- Cleaning Straight and Curved Tubes in Heat Exchangers, Condensers, Chillers, Absorbers, Water Heaters, Coolers and Other Small Diameter Pressure Vessels
- 3/8 to 1½-Inch (9.5 to 38.1mm) Outer Diameter Tubes
- Removing Light to Medium Soft Deposits

### Specifications

- Dolly Mounted  
 Drive Unit: 55 lbs.; 12" H x 23" W x 11½" D (25Kg; 305 x 584 x 292mm)
- Compact Drive Unit: 35 lbs.; 10" H x 18" W x 8½" D (16Kg; 254 x 457 x 216mm)
- Speed: 1,725 rpm  
 Power: 1/2 HP (WAW-500 Series)  
 1 HP (WAW-1000 Series)



Underwriters Laboratories Inc.®  
 Specific Models Only



Specific Models Only

### Wils-Away™ Kit Includes:

- Electric Drive Unit (either Dolly-Mounted or Compact Unit)
- Foot Pedal-Single Direction
- Spare Safety Shaft Coupling (WAW-500 Series *only*)
- 25-Foot Shaft & Casing (7.6 M)
- Set of 6 Nylon Spiral Brushes
- or-
- Expanding Bronze Brush and Spare Refill Set
- Service Manual

Twin Foot Pedal (for remote forward/reverse control) is an optional accessory.



Tube ID Range		Complete Kit†	consists of	Drive Unit	- and -	Flexible Shaft & Casing	- and -	6 Nylon <sup>1</sup> Spiral Brushes	- or -	Expanding <sup>2</sup> Bronze Brush
Inches	(mm)									
.281 - .311	(7.1 - 7.9)	WAW-500 (Dolly Mounted) - or - WAW-520 (Compact Unit) 115V 50/60 Hz		9600	- or -	9720-0015 (8 x 32 Female Thread)		61746-4025		-
.312 - .342	(7.9 - 8.7)							61746-4028		-
.343 - .374	(8.7 - 9.5)							61746-4031		-
.375 - .405	(9.5 - 10.3)							61746-4034		-
.406 - .436	(10.3 - 11.1)							62501-4037		-
.437 - .499	(11.1 - 12.7)							62501-4043		-
.500 - .561	(12.7 - 14.2)			62501-4050		-				
.562 - .624	(14.2 - 15.8)			62501-4056		9900-3003				
.625 - .686	(15.9 - 17.4)			62501-4062		9900-3006				
.687 - .749	(17.4 - 19.0)			62501-4068		2456-3002 <sup>3</sup>				
.750 - .811	(19.0 - 20.6)			62501-4075		2456-3003 <sup>3</sup>				
.812 - .874	(20.6 - 22.2)			62501-4081		2456-3004 <sup>3</sup>				
.875 - .936	(22.2 - 23.8)			62501-4087		2456-3006 <sup>3</sup>				
.937 - .999	(23.8 - 25.4)	62501-4093	2463-3004 <sup>3</sup>							
1.000 - 1.061	(25.4 - 26.9)	62501-4100	2463-3005 <sup>3</sup>							
1.062 - 1.124	(26.9 - 28.5)	WAW-1000 115V 50/60 Hz	9610	9728-0025 (9/16 x 12 Male Thread)	-	2463-3007 <sup>4</sup>				
1.125 - 1.186	(28.5 - 30.1)				-	2463-3008 <sup>4</sup>				
1.187 - 1.249	(30.1 - 31.4)				-	2470-3002 <sup>4</sup>				
					-					

† For other than 115V 50/60Hz units, order **WAW-510** (220V 50/60Hz), **WAW-530** (115V 50Hz), **WAW-540** (220V 60Hz), **WAW-550** (220V 50Hz) or **WAW-1100** (220V 50/60Hz)

1. For Steel Spiral Brushes, change the last four digits of the Part No. to "0XXX", for Stainless Steel "2XXX", for Brass "3XXX".  
 2. For Expanding Brush with Nylon bristles, change the last four digits to "4XXX", for Stainless Steel "5XXX", for Steel "0XXX".  
 3. These Expanding Brushes require an Adapter (Part No. 9589).  
 4. These Expanding Brushes require an Adapter (Part No. 9798).



**Smart Tool**

- Runs wet or dry. When run wet, water aids cleaning action, flushing away scale. When water is clear, the tube is clean!
- Operates both forward and reverse with Twin Foot Pedal.
- Simultaneous foot-controlled activation of motor direction and water flushing enables one-man operation.
- Available as either dolly-mounted or compact, easy-to-carry unit. Both units include storage compartment for accessories.

**Safety Shaft Coupling:**

WAW-500 and 520 Series drive units are equipped with a safety shaft coupling that snaps under accidental overload, protecting the shaft from breakage. A spare coupling and removal tool are supplied with each kit.



**Accessories**

**WAW-520 Compact Unit**

Spin Grit Brush	Spin Clean Brush	Cutter Bit with Adapter	Buffing Tool with Drill Tip	Expanding Scraper	Model A Cutter Head	U-Bend Cleaning Assembly
62551-0050	62615-0075	-	-	2569-9587	7211-9662	62690-5000 (Brass Cup Brush Type)
62551-0075		-	62622-0005			
62551-0100		7162-9949	62622-0006			
62551-0125	62615-0100	7163-9949	-	2575-9587	7212-9662	62660-0075 (Stainless Steel Wheel Brush Type)
	62615-0112	7163-9672	62622-0007	3055-9589	7213-9795	
		7164-9664	62622-0010	2578-9589	7218-9791	62660-0100 (Stainless Steel Wheel Brush Type)
		7165-9950		2586-9589	7215-9665	
		7166-9950		2592-9589	7216-9665	
		7167-9666		2600-9589	7217-4387	
		7168-9666		2606-9798	7282-4385	
		7169-9666				
		7170-9667				
		7171-9667				
		7172-9667				
		7173-4386				
		7778-4386				
		7792-4386	62626-6759			

# Heat Exchangers/Condensers

## MS Series Air-Driven Tube Cleaning System



### Applications

- Cleaning Straight Tubes in Heat Exchangers, Condensers, Chillers, Absorbers, Small Diameter Boilers, Other Pressure Vessels under 2 Inches Outer Diameter Pipelines
- 5/8 to 2-Inch (15.9 to 50.8mm) Outer Diameter Tubes
- Removing Light to Moderate Scale

### Specifications

- Speed: 8,000 to 10,000 rpm
- Air: 80 to 125 psi
- Motor: Steel rotor blades and precision ground surfaces result in high-performance and durability

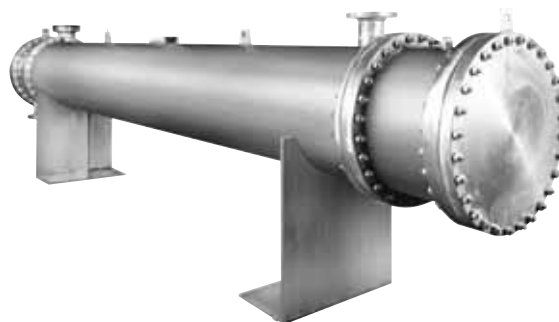

Shell and Tube Heat Exchanger

### MS Series Kit Includes:

- MS Air Motor
- Type C Flexible Holder
- Expanding Steel Brush with Spare Refill Set
- Model A Cutter Head with 4 Spare Sets of Cutters
- 25-Foot Air Line with Couplings
- Spare Set of Rotor Blades and Wrench
- Tool Box
- Service Manual



Tube ID Range		Complete Kit	consists of	Air Motor	- and - Type C Flexible Holder	- and - Expanding Steel Brush	- and - Model A Cutter Head	- and - Air Hose Part No.	Inches	Motor Diam.		CFM
Inches	(mm)									Inches	(mm)	
.500 - .624	(12.7 - 15.8)	MS-0		2996	2261	7000-0001	7211	9388-0025	3/16	15/32	(11.9)	9
.625 - .749	(15.9 - 19.0)	MS-1		3002		7000-0005	7212			9/16	(14.3)	10
.750 - .780	(19.0 - 19.8)	MS-1A		3050	2265	2456-0002	7213	7040-0025	1/4	11/16	(17.5)	12
.781 - .874	(19.8 - 22.2)	MS-1B				2456-0003				7215	49/64	(19.4)
.875 - .999	(22.2 - 25.4)	MS-3		8984	2279	2456-0004	7215	8971-0025	3/8	7/8	(22.2)	18
1.000 - 1.124	(25.4 - 28.5)	MS-4		8987		2463-0003				7216	31/32	(24.6)
1.125 - 1.217	(28.5 - 30.9)	MS-5		8989	2303	2463-0007	7217	8971-0025	3/8	1 1/2	(27.8)	30
1.218 - 1.311	(31.0 - 33.3)	MS-6		8992		2470-0002				7282	1 1/4	(32.1)
1.312 - 1.499	(33.3 - 38.1)	MS-7		8997	2296	2477-0001	5788	8972-0025	3/8	1 1/4	(32.1)	35
1.500 - 1.749	(38.1 - 44.4)	MS-8				2477-0005				5183	1 1/8	(31.8)
1.750 - 1.875	(44.4 - 47.6)	MS-10		8999		2484-0006	7231			1 1/8	(31.8)	30





**Smart Tool**

- Complete Kit includes air motor, all required accessories, spare parts, air hose, and tools required for a thorough tube cleaning job.
- Powerful 10,000 rpm air motor cleans in one pass, saving time and improving productivity.
- Kit includes two cleaning heads: expanding brush quickly and efficiently removes light deposits while Model A Cutter Head cuts through harder scale.
- Minimal moving parts improves reliability and durability.
- Kit includes spare rotor blades and wrench, as well as air hose.



**Surface Condenser**

**Accessories**



Expanding Scraper	Model B Cutter Head	Buffing Tool	Buffing Tool with Drill Tip	Model M Cutter Bit	Air Valve	Air Line Lubricator	Kit Weight (Less Options)			
							Pounds	(Kg)		
2569	8061	-	-	7771-4141	-	52035	4½	(1.9)		
2575	8062	62624-9010	62622-9010	7772-4142	-		4½	(2.2)		
3055	8063	62624-8010	62622-8010	7774-4143	-		5½	(2.4)		
2578				7775-4143	-		5½	(2.6)		
2586	8065	62624-7010	62622-7010	7776-4144	-		6	(2.7)		
2592	8066			7777-4144	-	7½	(3.4)			
2600	8067	62625-4140	62626-4140	7778-4145	8774	52399	8	(3.6)		
2606	8068	62625-9395	62626-9395	7779-4146			8774	52399	12½	(5.7)
2625	8069			7793-4146					13	(5.9)
2617	8070			7795-4147					14½	(6.4)
2634	8071	-	-	-			-	16	(7.3)	

# Heat Exchangers/Condensers

## Blo-Gun Air/Water Actuated Tube Cleaning System



### Applications

- Cleaning Tubes in Heat Exchangers, Condensers, Chillers, Absorbers, Water Heaters, Coolers, and Other Small Diameter Pressure Vessels
- 3/8 to 1-Inch (9.5 to 25.4mm) Outer Diameter Tubes
- Removing Light to Medium Soft Deposits
- Ideal for Removing Soft Mud or Marine Growth that Is Typical in Steam Condensers, Chillers, and Absorbers

### Smart Tool

- Fastest method for cleaning tubes. *Ideal when time is critical and there is a large number of tubes to clean!*
- Lightweight tool minimizes user fatigue, and Blo-Gun can be used anywhere.
- Re-usable Blo-Plugs or Blo-Brushes are economical.
- Can be powered by compressed air or water.
- Safety shield protects operator.
- No trigger: just push forward to activate!

### Blo-Gun Kit Includes

- Blo-Gun with Spare Shield
- Package of 25 Blo-Plugs
- Package of 6 Blo-Brushes
- Air/Water Hose
- Tool Box
- Service Manual



Tube ID Range Inches (mm)	Complete Kit	consists of	Blo-Gun	Blo-Plugs (Pckg of 25)		Blo-Brushes (Pckg of 6)		Spare Shield	Air/Water Hose
				Part No.	Diam.	Part No.	Diam.		
.287 - .314 (7.3 - 8.0)	BG		8044			9642-0018	.287	8086	8973-0025 (1/2 Inch)
.315 - .328 (8.0 - 8.3)						9642-0020	.315		
.329 - .369 (8.3 - 9.4)						9642-0022	.329		
.402 - .429 (10.2 - 10.9)				8296-0018	.402	8301-0018	.412		
.430 - .443 (10.9 - 11.3)				8296-0020	.430	8301-0020	.440		
.444 - .458 (11.3 - 11.6)				8296-0022	.444	8301-0022	.454		
.527 - .540 (13.4 - 13.7)				8297-0018	.527	8302-0018	.550		
.541 - .554 (13.7 - 14.1)				8297-0019	.541	8302-0019	.565		
.555 - .568 (14.1 - 14.4)				8297-0020	.555	8302-0020	.580		
.569 - .583 (14.4 - 14.8)				8297-0022	.569	8302-0022	.594		
.652 - .679 (16.5 - 17.2)			8298-0018	.652	8303-0018	.677			
.680 - .693 (17.2 - 17.6)			8298-0020	.680	8303-0020	.705			
.694 - .708 (17.6 - 18.0)			8298-0022	.694	8303-0022	.719			
.777 - .804 (19.7 - 20.4)			8299-0018	.777	8304-0018	.807			
.805 - .818 (20.4 - 20.8)			8299-0020	.805	8304-0020	.835			
.819 - .833 (20.8 - 21.2)			8299-0022	.819	8304-0022	.849			
.902 - .929 (22.9 - 23.6)			8300-0018	.902	8305-0018	.935			
.930 - .943 (23.6 - 24.0)			8300-0020	.930	8305-0020	.961			
.944 - .958 (24.0 - 24.3)			8300-0022	.944	8305-0020	.975			

### Accessories



Nozzle Extension

Description	Part No.
18" Nozzle Extension	8471-0018
24" Nozzle Extension	8471-0024
30" Nozzle Extension	8471-0030
Service Manual	SM-16
Tool Box	6404-0002



Dowel Brush

Tube ID Range Inches (mm)	Dowel Brush	Brush Diam.
.652 - .665 (16.6 - 16.9)	62728-0018	.662
.666 - .679 (16.9 - 17.3)	62728-0019	.676
.680 - .693 (17.3 - 17.6)	62728-0020	.690
.694 - .707 (17.6 - 18.0)	62728-0022	.704
.777 - .790 (19.7 - 20.1)	62729-0018	.787
.791 - .804 (20.1 - 20.4)	62729-0019	.801
.805 - .818 (20.4 - 20.8)	62729-0020	.815
.819 - .832 (20.8 - 21.1)	62729-0022	.829
.902 - .915 (22.9 - 23.3)	62730-0018	.912
.916 - .929 (23.3 - 23.6)	62730-0019	.926
.930 - .943 (23.6 - 24.0)	62730-0020	.940
.944 - .957 (24.0 - 24.3)	62730-0022	.954



# Wils-Away™ Pneumatic Tube Cleaning System



## Applications

- Cleaning Tubes in Heat Exchangers, Condensers, Chillers, Absorbers, Water Heaters, Coolers, and Other Small Diameter Pressure Vessels
- 3/8 to 1½-Inch (9.5 to 38.1mm) Outer Diameter Tubes
- Removing Medium to Hard Deposits
- Ideal Cleaning System when Electric Power is Not Available
- Air Motor Enables Operator to Control Speed of Cleaning Head and Shaft & Casing Rotation

## Specifications

### Dolly-Mounted

Drive Unit: 58 lbs.; 12" H x 23" W x 11½" D (26Kg; 305 x 584 x 292mm)

Compact Drive Unit: 32 lbs.; 10" H x 18" W x 8½" D (14Kg; 254 x 457 x 216mm)

Speed: 500 to 3,000 rpm

Air Consumption: 15 CFM @90 psi (WAW-3000)  
40 CFM @90 psi (WAW-4000)

Power: 1½ HP (WAW-3000)  
4 HP (WAW-4000)

Air Hose: 3/8" Minimum  
1/2" - 50 Feet - **Part No. 9600-0121**

## Smart Tool

- Kit includes drive unit and all accessories required for thorough tube cleaning.
- Spiral brushes clean many tubes in one pass.
- Expanding brush removes heavier deposits.
- Runs wet or dry without lubrication.
- When run wet, water aids cleaning action and flushes away debris. When the water is clear, the tube is clean!
- WAW-3000 offers forward/reverse drive via remote foot pedal.
- Air-activated foot pedal ensures operator safety.

## Wils-Away™ Pneumatic Kit Includes

- Dolly-Mounted or Compact Drive Unit with Tool Compartment
- Flexible Shaft & Casing
- Foot Pedal
- 6 Nylon Spiral Brushes
- or -
- Expanding Bronze Brush and Spare Refill Set
- Service Manual

The **WAW-3000** and **WAW-4000** use the same accessories as the **WAW-500/1000** series, so refer to the chart on Page 4 for accessories.

Tube ID Range		Complete Kit†	consists of	Drive Unit	- and - Flexible Shaft & Casing	- and - 6 Nylon <sup>1</sup> Spiral Brushes	- or - Expanding <sup>2</sup> Bronze Brush
Inches	(mm)						
.281 - .311	(7.1 - 7.9)	WAW-3000 (1½ HP Compact Unit) -or- WAW-4000 (4 HP Dolly Mounted Unit)		9502	9720-0015 (8x32 Female Thread)	61746-4025	-
.312 - .342	(7.9 - 8.7)					61746-4028	-
.343 - .374	(8.7 - 9.5)					61746-4031	-
.375 - .405	(9.5 - 10.3)					61746-4034	-
.406 - .436	(10.3 - 11.1)					62501-4037	-
.437 - .499	(11.1 - 12.7)					62501-4043	-
.500 - .561	(12.7 - 14.2)					62501-4050	-
.562 - .624	(14.2 - 15.8)					62501-4056	9900-3003
.625 - .686	(15.9 - 17.4)					62501-4062	9900-3006
.687 - .749	(17.4 - 19.0)					62501-4068	2456-3002 <sup>3</sup>
.750 - .811	(19.0 - 20.6)					62501-4075	2456-3003 <sup>3</sup>
.812 - .874	(20.6 - 22.2)					62501-4081	2456-3004 <sup>3</sup>
.875 - .936	(22.2 - 23.8)					62501-4087	2456-3006 <sup>3</sup>
.937 - .999	(23.8 - 25.4)					62501-4093	2463-3004 <sup>3</sup>
1.000 - 1.061	(25.4 - 26.9)					62501-4100	2463-3005 <sup>3</sup>
1.062 - 1.124	(26.9 - 28.5)	9728-0025 (9/16x12 Male Thread)	2463-3007 <sup>4</sup>				
1.125 - 1.186	(28.5 - 30.1)		2463-3008 <sup>4</sup>				
1.187 - 1.249	(30.1 - 31.4)		2470-3002 <sup>4</sup>				

1. For Steel Spiral Brushes, change the last four digits of the Part No. to "0XXX", for Stainless Steel "2XXX", for Brass "3XXX".  
2. For Expanding Brush with Nylon bristles, change the last four digits to "4XXX", for Stainless Steel "5XXX", for Steel "0XXX".  
3. These Expanding Brushes require an Adapter (**Part No. 9589**).  
4. These Expanding Brushes require an Adapter (**Part No. 9798**).





### Applications

- Cleaning Tubes in Heat Exchangers, Condensers, Refinery Fixtures, Chillers, Absorbers, Water Heaters, Coolers, Evaporators, and Other Small Diameter Pressure Vessels
- 1/4 to 1 1/4-Inch (6.4 to 31.8 mm) Outer Diameter Tubes
- Removing Heavy Deposits and Cleaning Out Clogged Tubes

### Specifications

- Speed: 8,000 to 10,000 rpm
- Air: 80 to 125 psi
- Motor: Two models cover a wide range of tube sizes

### PG Series Kit Includes:

- PG or PGX-2 Air Motor
- 4 5-Foot Drill Shafts
- 2 M Cutter Bits
- 2 M/SPE-DUR Cutter Bits
- Spare Rotor Blades
- 3/8-Inch Scavenging Hose (15 Feet/4.5M)
- Set of Spare Rotor Blades, Rotor Wrench, and Adjustable Wrench
- Tool Box
- Service Manual



Tube ID Range Inches (mm)	Complete Kit <i>consists of</i>	Air Motor	- and -	5-Foot Ext. Shafts (4)	- and -	M Cutter Bits (2)*	- and -	M/SPE-DUR Bit Adapters (2)	Scavenging Hose
.187 - .205 (4.7 - 5.2)	PG	7005				61242-00XX*			8042-0015 (3/8 Inch)
.206 - .304 (5.2 - 7.7)						62327-00XX*			
.305 - .318 (7.7 - 8.1)						60605-00XX*			
.319 - .374 (8.1 - 9.5)									
.375 - .437 (9.5 - 11.1)	PGX-2	9288				7769	7189		
.438 - .499 (11.1 - 12.7)						6207-0005		7770	
.500 - .562 (12.7 - 14.3)						6208-0005	7771	7192	
.563 - .624 (14.3 - 15.8)						6209-0005	7786	7194	
.625 - .686 (15.9 - 17.4)							7772		
.687 - .749 (17.4 - 19.0)						6210-0005	7773	7196	
.750 - .811 (19.1 - 20.6)							7774		
.812 - .874 (20.6 - 22.2)							7775		
.875 - .937 (22.2 - 23.8)							7776		
.938 - .968 (23.8 - 24.6)						6211-0005	7790	7199	
.969 - 1.062 (24.6 - 27.0)	7777								

\* For Inner Diameter Range .187 - .374 inches (4.7-9.5mm) a Bit and Shaft Assembly is provided. Insert "24", "36" or "48" as the last two digits of the Part No. to designate the shaft length that is required.



**Smart Tool**

- Carbide-tipped Type M Cutter Bits literally drill through the heaviest deposits... even totally clogged tubes!
- Cleaning depth is easily increased by adding 5-foot hollow extension shafts.
- Scavenging hose sends water down the extension shafts, cooling the cutter bit and providing flushing action.
- Water flushing clears away debris. When water is clear, the tube is clean!
- Direct drive increases power and minimizes moving parts.



**Accessories**

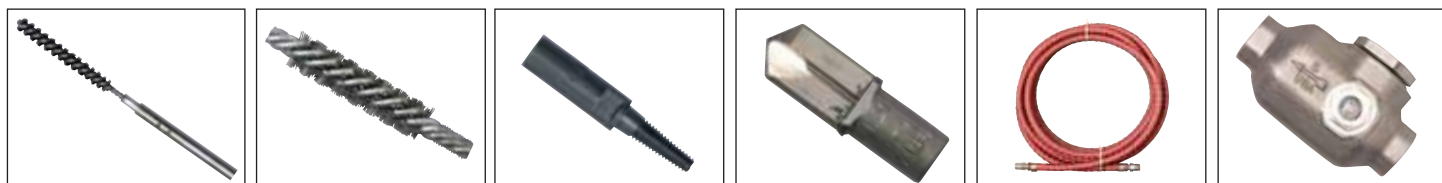

Brush and Shaft Assembly (St. Steel)*	P Brush (Steel)†	P Brush Adapter	SPE-DUR Cutter Bit	Air Hose Part No. Inches	Air Line Lubricator
62280-21XX	62280-0018†			8973-0025 1/2	53360
62430-21XX	62430-0021†				
62432-21XX	61746-0031†				
62433-21XX	61746-0032†				
	8543-0138	9275	7162	8975-0025 3/4 (Armored)	53361
	8543-0143		7163		
	8543-0150	9276	7164		
	8543-0155	9379	7165		
	8544-0162		7166		
	8544-0167	9283	7167		
	8544-0174		7168		
	8544-0182		7169		
	8545-0186	9284	7170		
	8545-0193		7171		
	8545-0196		7172		

\* For Bronze brushes, change last four digits to "31XX", for Nylon "41XX".  
 † For Bronze P Brush, change last four digits to "3XXX", for Nylon "4XXX".



## Wils-Away™ Electric Tube Cleaning System



### Applications

- Cleaning Straight Tubes in Fire Tube Boilers, Air Heaters and Other Pressure Vessels
- 1½ to 4½-Inch (38.1 to 114.3 mm) Outer Diameter Tubes
- Removing Soot and Scale

### Specifications

- 1 HP Drive Unit: 62 lbs. (28kg)
- 2 HP Drive Unit: 72 lbs. (32kg)
- Dimensions: 12" H x 23" W x 11½" D (305 x 584 x 292mm)
- Speed: 1,725 rpm
- Power: 1 HP (WAW-1500/1600)  
2 HP (WAW-2500/2600)
- Current: 115 Volt 50/60Hz (WAW-1500)  
220 Volt 50/60Hz (WAW-1600)  
220 Volt 60Hz (WAW-2500)  
220 Volt 50Hz (WAW-2600)



Underwriters Laboratories Inc.®  
Specific Models Only



Specific Models Only

### Wils-Away™ Kit Includes:

- Electric Drive Unit with Detachable Dolly and Built-In Tool Box
- Foot Pedal-Single Direction
- 25-Foot (7.6M) Flexible Shaft & Casing
- Vacuum Connector Nozzle
- Set of 6 Steel Spiral Brushes and Adapter  
- or -
- Expanding Steel Brush with Spare Refill Set and Adapter
- Service Manual

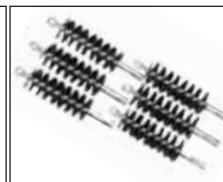

Tube ID Range Inches (mm)	Complete Kit consists of	Drive Unit	- and -	Shaft & Casing	- and -	6 Steel Spiral Brushes	- or -	Shaft Adapter	- and -	Expanding Steel Brush
1.250 - 1.499 (31.8 - 38.1)	WAW-1500	9610	- and -	9730-9025' (9/16 x 12 Male Thread)	- and -	62540-0125	- or -	9893 (1/4 FEM NPT)	- and -	2477-0001 <sup>2</sup>
1.500 - 1.749 (38.1 - 44.4)						62540-0150				2477-0006 <sup>2</sup>
1.750 - 1.999 (44.5 - 50.8)						62540-0175				2492-0006
2.000 - 2.249 (50.8 - 57.1)						62540-0200				2501-0007
2.250 - 2.499 (57.2 - 63.5)						62540-0225				3441-0005
2.500 - 2.749 (63.5 - 69.8)						62540-0250				3441-0010
2.750 - 2.999 (69.9 - 76.2)						62540-0275				3456-0003
3.000 - 3.249 (76.2 - 82.5)	WAW-2500	9630	- and -	9732-0025 (3/4 x 10 Male Thread)	- and -	62540-0300	- or -	9894 (1/4 FEM NPT)	- and -	3456-0006
3.250 - 3.449 (82.6 - 88.9)						62540-0325				3470-0004
3.500 - 3.749 (88.9 - 95.2)						62540-0350				3470-0007
3.750 - 3.999 (95.3 - 101.6)						62540-0375				3470-0009
4.000 - 4.250 (101.6 - 108.0)						62540-0400				4060-0006 <sup>3</sup>

1. When cleaning Water Tube Boilers, use Part No. 9728-0025.  
2. Requires Adapter (Part No. 6759).  
3. Requires Adapter (Part No. 2705).





**Smart Tool**

- Each kit includes electric drive unit and all accessories and tools required for thorough tube cleaning.
- Spiral steel brush removes soot in one pass.
- Expanding brush cuts through scale.
- Optional vacuum unit collects soot, keeping work area clean.
- Optional twin foot pedal enables forward/reverse drive.



For *air-powered* tube cleaning, specify the **WAW-4500** Pneumatic Tube Cleaning System. Determine tube Inner Diameter, then select components and accessories from the **WAW-1500/2500** charts. **WAW-4500** uses 1/2-inch Air Hose.

**Accessories**



Expanding Scraper	Drill Head with Universal	Vacuum Nozzle*	Vacuum Cleaners	Vacuum Kits
2606-4151	5185	9877-1500	<b>9487</b> 2 HP Motor with 15-Gallon Drum (115V 60Hz) - or - <b>9715-1055</b> 4 HP Motor with 55-Gallon Drum (115V 60Hz)	<b>9487-1000:</b> General Purpose Vacuum Kit <b>9490-0000:</b> Disposable Vacuum Bags (Pkg of 5) <b>9487-2000:</b> Filter Bag <b>9488-0010:</b> 10-ft Hose  <b>9715-0300:</b> General Purpose Vacuum Kit <b>9715-0100:</b> 15-ft Hose <b>9715-0400:</b> Main Filter <b>9715-0500:</b> Pre Filter
2617-6759	5186	9877-1750		
2634-6759	7225	9877-2000		
7985-3070	406-2180	9877-2250		
7987-3070	405-4129	9877-2500		
7989-6261		9877-2750		
7991-3077	403-2202	9877-3000		
7992-3079	402-2202	9877-3250		
7993-3079		9877-3500		
7994-6930	401-2202	9877-3750		
7995-6930		9877-4000		
3571-2705	400-4500	9877-4250		



2 HP Vacuum Cleaner



4 HP Vacuum Cleaner

\* Requires Connector (Part No. 9875).

# FT Series Air-Driven Tube Cleaning System



## Applications

- Cleaning Pipes or Straight Tubes in Fire Tube Boilers and Other Pressure Vessels
- 2 to 4½-Inch (50.8 to 114.3mm) Outer Diameter Tubes
- Removing Powdery and Gummy to Soft Scale

## Specifications

- Speed: Up to 6,000 rpm
- Air: 80 to 125 CFM
- Motor: Positive starting, non-stalling; six-blade rotor and double-chambered power seal cylinder



## Smart Tool

- Each kit includes air motor and all accessories required for thorough tube cleaning.
- Powerful air motor speeds cleaning.
- One-man operation improves productivity.
- Expanding brush removes dry and scaly residue.
- Expanding scraper cuts through soft or gummy deposits.
- Optional CHJ Cutter Head cleans out heavy deposits.

## FT Series Kit Includes:

- EP Air Motor
- Type C Flexible Holder
- Expanding Steel Brush and Spare Refill Set
- or -
- Expanding Scraper and Spare Set of Scrapers
- Set of Spare Rotor Blades and Rotor Wrench
- Tool Box
- Service Manual



Tube ID Range Inches (mm)	Complete Kit	consists of	Air Motor	and	Expanding Steel Brush	or	Expanding Scraper	Motor Diam. Inches (mm)	CFM
1.750 - 2.124 (44.5-53.9)	FT-175		2000-0156		2492-0006		2635	1½ (39.7)	47
2.125 - 2.624 (54.0-66.6)	FT-212		2012-0200		3442-0001		7986-2416	2 (50.8)	70
2.625 - 3.124 (66.7-79.3)	FT-262		7968-0256		3456-0001		7990-2354	2¾ (65.1)	73
3.125 - 3.624 (79.4-92.0)	FT-312		2058-0300		3471-0002		7992-3080	3 (76.2)	108
3.625 - 4.125 (92.1-104.8)	FT-362		2058-0350		3471-0007		7994-3081	3½ (88.9)	

## Accessories



FT Kit	CHJ Series Cutter Head	Drill Head with Universal	Armored Air Hose Part No.	Inches	Air Valve	Air Line Lubricator	Kit Weight (Less Options) Pounds (Kg)
FT-175	4261-3996	7225	8974-0025	1/2	8654	53360	5½ (2.5)
FT-212	4344-4382	406-2209	8975-0025	3/4	8647	53361	9¾ (4.3)
FT-262	3209-6518	405-4952					10¾ (4.6)
FT-312	3215-6919	402-2208	8976-0025	1	8669	53363	17¾ (7.9)
FT-362	3219-6919	401-2208					19¾ (8.8)

## Wils-Away™ Electric Plant Manager's Kit



### Applications

- Cleaning **BOTH** Boilers and Heat Exchangers
- 3/8 to 4½-Inch (9.5 to 114.3mm) Outer Diameter Tubes
- Removing Soot and Scale from Boiler, Light to Medium Soft Deposits from Heat Exchanger

### Specifications

1 HP Drive Unit:	62 lbs. (28Kg)
Dimensions:	12" H x 23" W x 11½" D (305 x 582 x 292mm)
Speed:	1,725 rpm
Power:	1 HP (WAW-1500/1600)
Current:	115 Volt 50/60Hz (WAW-1500) 115 Volt 50Hz (WAW-1600)

### Plant Manager's Kit Includes:

- Electric Drive Unit with Detachable Dolly and Built-In Tool Box
- Foot Pedal-Single Direction
- 25-Foot Flexible Shaft & Casing (for cleaning Heat Exchanger)
- 25-Foot Flexible Shaft & Casing (for cleaning Boiler)
- 6 Nylon Spiral Brushes or Expanding Brush (for cleaning Heat Exchanger)
- Expanding Brush with Refill Set (for cleaning Boiler)
- Vacuum Connector Nozzle
- Service Manual

Determine Inner Diameter of Heat Exchanger and Inner Diameter of Boiler, then select two Shaft & Casings, one for Heat Exchanger and one for Boiler. Select either set of 6 Spiral Brushes or Expanding Brush to clean Heat Exchanger, and select Expanding Brush to clean Boiler.

	Tube ID Range		Complete Kit	Drive Unit	Shaft & Casing	6 Nylon Spiral Brushes	Expanding Brush*	Brush Adapter	Vacuum Nozzle†
	Inches	(mm)							
▲ Heat Exchanger Tube ID -	.281 - .311	(7.1 - 7.9)	WAW-9000	9610 (115V 50/60Hz) - or - 9610-2200 (220V 50Hz)	9720-0015 (8x32 Female Thread)	61746-4025	9900-3003 9900-3006 2456-3002 2456-3003 2456-3004 2456-3006 2463-3004 2463-3005 2463-3007 2463-3008 2470-3002	9589 (5/16x18 Female Thread)	
	.312 - .342	(7.9 - 8.7)				61746-4028			
	.343 - .374	(8.7 - 9.5)				61746-4031			
	.375 - .405	(9.5 - 10.3)				61746-4034			
	.406 - .436	(10.3 - 11.1)				62501-4037			
	.437 - .499	(11.1 - 12.7)				9722-0025 (1/4x28 Female Thread)			
	.500 - .561	(12.7 - 14.2)			62501-4050	62501-4056			
	.562 - .624	(14.2 - 15.8)			62501-4062	62501-4068			
	.625 - .686	(15.8 - 17.4)			9724-0025 (1/4x28 Female Thread)	62501-4075			
	.687 - .749	(17.4 - 19.0)			62501-4081	2456-3004			
	.750 - .811	(19.0 - 20.6)			62501-4087	2456-3006			
	.812 - .874	(20.6 - 22.2)			62501-4093	2463-3004			
	.875 - .936	(22.2 - 23.8)			9728-0025 (9/16x12 Male Thread)	62501-4100			
	.937 - .999	(23.8 - 25.4)			-	-			
1.000 - 1.061	(25.4 - 26.9)	-	-						
1.062 - 1.124	(26.9 - 28.5)	-	-						
1.125 - 1.186	(28.5 - 30.1)	-	-						
1.187 - 1.249	(30.1 - 31.7)	-	-						
▲ - Boiler Tube ID -	1.250 - 1.499	(31.8 - 38.1)	WAW-9100	9630 (220V 60Hz) 9630-2250 (220V 50Hz)	9730-9025 (9/16x12 Male Thread)	2477-0001	2477-0006 2492-0006 2501-0007 3441-0005 3441-0010 3456-0003 3456-0006 3470-0004 3470-0007 3470-0009 4060-0060	6759 (7/16x14 Female Thread)	9877-1500
	1.500 - 1.749	(38.1 - 44.4)				9877-1750			
	1.750 - 1.999	(44.5 - 50.8)				9877-2000			
	2.000 - 2.249	(50.8 - 57.1)				9877-2250			
	2.250 - 2.499	(57.2 - 63.5)				9877-2500			
	2.500 - 2.749	(63.5 - 69.8)				9877-2750			
	2.750 - 2.999	(69.9 - 76.2)			9877-3000				
	3.000 - 3.249	(76.2 - 82.5)			9877-3250				
	3.250 - 3.349	(82.6 - 88.9)			9732-0025 (3/4x10 Male Thread)	9877-3500			
	3.350 - 3.749	(88.9 - 95.2)			9877-3750				
	3.750 - 3.999	(95.3 - 101.6)			9877-4000				
	4.000 - 4.250	(101.6 - 108.0)			2705 (7/8x9 Male Thread)	9877-4250			

\* Bronze Expanding Brush up to 1.249 Tube Inner Diameter; Steel Expanding Brush for 1.250 Tube Inner Diameter and larger.

† Requires Connector (Part No. 9875).



## C Series Air-Driven Tube Cleaning System



### Applications

- Cleaning Curved or Straight Tubes or Pipes in Water Tube Boilers, Other Pressure Vessels, Transmission Lines and Many Other Applications
- 1 to 2½-Inch (25.4 to 63.5mm) Outer Diameter Tubes
- Removing Light to Medium Soft Deposits

### Specifications

- Speed: 9,000 rpm
- Air: 80 to 125 psi
- Motor: Steel rotor blades and precision ground surfaces result in high-performance and durability

### C Series Kit Includes:

- C Air Motor
- Type C Flexible Holder
- Expanding Steel Brush and Spare Refill Set - and -
- Model A Cutter Head and Spare Set of Cutters
- 25-Foot Air Hose with Coupling
- Set of Spare Rotor Blades and Rotor Wrench
- Tool Box
- Service Manual

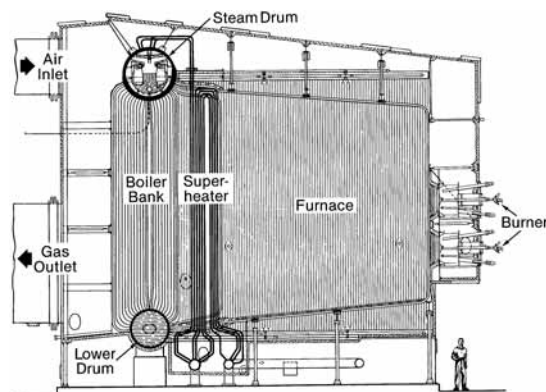

Industrial Water Tube Boiler



Tube ID Range Inches (mm)	Kit	Air Motor consists of	- and -	Flexible Holder	- and -	Expanding Steel Brush	- and -	Model A Cutter	- and -	Air Hose Part No.	Inches	Motor Diam.		CFM
												Inches	(mm)	
.781 - .874 (19.8 - 22.2)	C-2	2745		2265		2456-0002		7213		7040-0025	1/4	11/16	(17.5)	12
.875 - .999 (22.2 - 25.4)	C-3	2755		2271		2456-0004		7218		7040-9025	1/4	49/64	(19.4)	13
1.000 - 1.124 (25.4 - 28.5)	C-4	2763		2279		2463-0003		7219		8971-0025	3/8	7/8	(22.2)	18
1.125 - 1.217 (28.6 - 30.9)	C-5	2773				2463-0007		7220				31/32	(24.6)	25
1.218 - 1.499 (31.0 - 38.1)	C-6	2783		2285		2470-0001		7221				1½	(27.8)	30
1.500 - 1.749 (38.1 - 44.4)	C-8			2296		2477-0005		7222		8972-0025	3/8	1¼	(32.1)	35
1.750 - 1.999 (44.5 - 50.8)	C-8A*	2793		-		2678-0004		7223		Armored		1½	(34.1)	40
2.000 - 2.250 (50.8 - 57.2)	C-10	2799		2296		2484-0006						1½	(40.5)	40
	C-12	8588		2862		2493-0006		7224		8974-0025 Armored	1/2	1½	(40.5)	50

\* Package Boiler Kit



**Smart Tool**

- Complete kit includes air motor, all required accessories, spare parts, air hose and tools required for a thorough tube cleaning job.
- Air motor has power needed to remove scale.
- One-man operation improves productivity.
- Expanding brush removes light deposits without damaging tube wall.
- Cutter head cuts through heavier deposits and hard scale.
- For soft, dusty deposits, use expanding brush.
- For gummy deposits, use expanding scraper.
- For hard, cement-like scale, use Model A Cutter Head.



Although the C-Series Kits are recommended, please see page 9 for a Wils-Away™ Pneumatic alternative.

**Accessories**

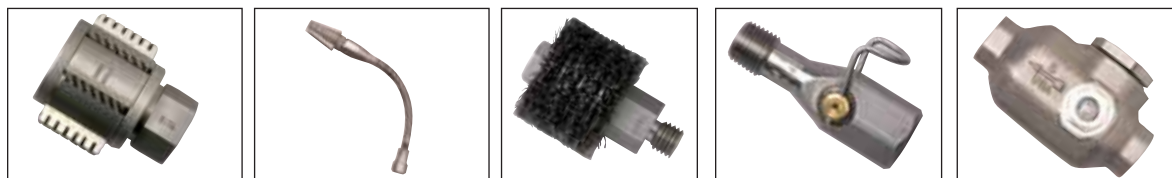

Expanding Scraper	Model B Cutter Head	Sectional Steel Brush	Air Valve	Air Line Lubricator	Kit Weight (less options)	
					Pounds	(Kg)
2578	8063	8353-0068	-	52035	4½	(2.2)
2586	8072	8353-0075	-		5	(2.3)
2592	8066	8353-0081	9439		6	(2.7)
2600	8073	8354-0100	-		8½	(3.7)
2506	8074	8354-0106	8774	52399	11½	(5.1)
2617	8069	8356-0131			11½	(5.3)
-	-	-			12	(5.4)
2634	8070	8357-0156	8654	53360	12½	(5.8)
2043	8075	8358-0175			17½	(7.8)



## ECT Series Air-Driven Tube Cleaning System



### Applications

- Cleaning Curved or Straight Tubes in Boilers, Superheaters, Economizers, and Other Large Diameter Pressure Vessels
- 2½ to 7½-Inch (63.5 to 190.5mm) Outer Diameter Tubes
- Removing Medium to Heavy Hard Deposits

### Specifications

- Speed: 10,000 rpm
- Air: 80 to 125 psi
- Motor: Phenolite rotor blades and precision ground surfaces result in high-performance and durability

### Smart Tool

- Powerful air motor and extra duty cleaning heads remove even the heaviest deposits.
- CHJ Cutter Head removes medium hard deposits in one pass.
- SE Cutter Head cuts through heavier deposits.
- Use Expanding Brush or Expanding Scraper for light duty cleaning applications.

### ECT Series Kit Includes:

- ECT Air Motor with Set of Spare Rotor Blades
- CHJ or SE Cutter Head with Spare Set of Cutters, Cutter Pins, and Hinge Pins
- Tool Box and Set of Wrenches
- Service Manual

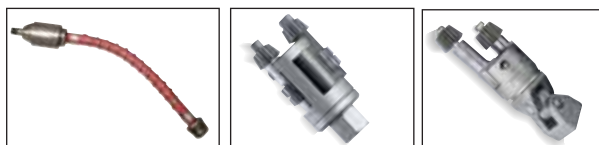

Tube ID Range Inches (mm)	Complete Kit includes	Air Motor	- and -	Model CHJ Cutter Head	- or -	Model SE Cutter Head	Motor Diam. Inches (mm)	CFM
2.125 - 2.374 (54.0 - 60.3)	ECT-212	4090-0175		4195-4606		4599-4606	1¼ (44.5)	35
2.375 - 2.624 (60.3 - 66.6)	ECT-237	4090-0200		3203-4650		4595-4650	2 (50.8)	
2.625 - 2.874 (66.7 - 73.0)	ECT-262	4925-0225		3203-4596		4595-4596	2¼ (57.2)	55
2.875 - 3.124 (73.0 - 79.3)	ECT-287	4099-0256		3230-4596		4632-4596	2⅝ (65.1)	
3.125 - 3.624 (79.4 - 92.0)	ECT-312	4035-0275		3230-9308		4640-4644	2⅞ (69.9)	85
3.625 - 3.999 (92.1 - 101.6)	ECT-362	4035-0318		3237-4644			3⅞ (81.0)	
4.000 - 4.499 (101.6 - 114.3)	ECT-400	4541-0325		3237-9966		3971-2631	3¼ (82.6)	110
4.500 - 4.999 (114.3 - 127.0)	ECT-450	4541-0375		3226-6558		4117-2631	3⅝ (95.3)	
5.000 - 5.499 (127.0 - 139.7)	ECT-500	4315-0425					4¼ (108.0)	125
5.500 - 5.999 (139.7 - 152.4)	ECT-550	4315-0450					4½ (114.3)	
6.000 - 6.499 (152.4 - 165.1)	ECT-600	4315-0500		2174-7274		4121-3153	5 (127.0)	
6.500 - 7.000 (165.1 - 177.8)	ECT-650	4315-0550				-	5½ (139.7)	

### Accessories



ECT Kit	Expanding Steel Brush	Expanding Scraper	Sectional Steel Brush	Drill Head with Universal	Air Hose Part No. Inches	Air Valve	Air Line Lubricator	Kit Weight (Less Options) Pounds (Kg)
ECT-212	3442-0001	7985-2416	8359-0200 <sup>1</sup>	407-2180	8974-0025 1/2	8654	53360	6½ (2.9)
ECT-237	3442-0005	7987-2416	8360-0225 <sup>1</sup>	406-2209				8 (3.6)
ECT-262	3444-0010	7989-2354	8361-0250 <sup>2</sup>	405-4952	8975-0025 3/4	8647	53361	9 (4.1)
ECT-287	3456-0003	7991-3077						403-2208
ECT-312	3471-0002	7992-3080		402-2208	8976-0025 1	8669	53363	19 (8.6)
ECT-362	3471-0007	7994-3081		401-2196				19½ (8.9)
ECT-400	4060-0007	3571-4021						20¼ (9.0)
ECT-450	3497-0437	3576-4021						20¾ (9.4)
ECT-500	3500-0500	3578-3513		400-2631				26¼ (11.9)
ECT-550			31 (14.1)					
ECT-600								32 (14.5)
ECT-650								35¼ (16.0)

1. Requires Universal Joint (Part No. 2209). 2. Requires Universal Joint (Part No. 4952).



## Gas Line Renewal Kit



### Applications

- Cleaning 3/4 to 2-Inch Pipe (Schedule 40) Gas Lines prior to Installation of Replacement Tubing
- Cone Cutter and Cutter Wheel Create Powerful Chipping Action that Removes Any Deposits in the Line
- Optional **Cherry Burr (Part No. 9838)** Provides Extra Cleaning Action for 3/4-Inch Pipe
- Kit Includes Everything Needed for Thorough Gas Line Tube Cleaning, including Tool Box (Part No. 6404-0001)



Pipe Size		Kit	Air Motor	Motor Diam		CFM (@90psi)	Model A Cutter Head	Universal Joint	Cone Cutters (3)	Cutter Wheels (24)	Rotor Wrench
Inches	ID			Inches	(mm)						
3/4	.824	9710	3050	11/16 (17.5)	12	62598	3062	19	34	2001	
1	1.049	9711	8987	7/8 (22.2)	18	62599	2242	22	83	2016	
1 1/4	1.380	9712	8992	1 1/2 (27.8)	30	62600	2212	41-0437		2031	
1 1/2	1.610	9713	3942-0143	1 5/8 (36.5)	45	62601		27	75-0562		3951
2	2.067	9714	2000-0156	1 5/8 (39.7)	47	62720	2140	14	72-0562		5760

## Aerco Water Heater Cleaning System



### Applications

- Removing Soot and Scale from Fire Tubes in Aerco Water Heaters
- Flexible Shaft & Casing and Expanding Brush Maneuver around Curves
- Special Teflon Shaft Can Be Run Dry without Damage to Shaft & Casing Assembly
- Kit Includes Drive Unit, Teflon Shaft & Casing, Stainless Steel Expanding Brush and Stainless Steel Refill Set

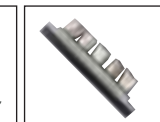
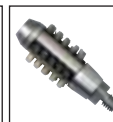

Aerco Tube ID		Kit	Drive Unit	Shaft & Casing	Expanding Brush	Brush Refill Set
Inches	(mm)					
.621 - .652	(15.7 - 16.6)	9611	9600	9722-6012	9900-0006	7003-0006

## Catalyst Cleaning System

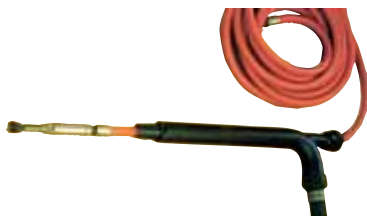

### Applications

- Removing Spent Catalyst from 1 1/2 to 5-Inch (30.2 - 127.0mm) Tubes in Reactor Units
- Powerful Air Motor is Lightweight and Maneuverable, Specially Designed for Overhead Cleaning
- Special Nozzle Attachment Directs Catalyst into Collection Container
- Kit Includes Air Motor, Cleaning Head with Adapter, Elbow Unit and Conveyor Tube Assembly, Air Hose, Rotor Blade and Wrench, Dust Seal Cap and Dust Seal Adapter, and Washer and Seal
- Standard Kit Cleans 2-Inch (50.8mm) Outer Diameter Tubes
- For Other Sizes, Specify Tube Inner Diameter, and We Will Configure Kit for that Application

Reactor Tube ID		Kit	Air Motor	Type K Cutter Bit	F-F Adapter	Elbow Unit Assembly	Conveyor Tube Assembly	50-Foot Air Hose	Rotor Blade	Wrench
Inches	(mm)									
1.812 - 1.936	(46.0 - 49.2)	62716	62546	7706	9011	62716-0001	62716-0002	62716-0004	2005	2014

# Spiral Brushes



**Wilson** Spiral Brushes are economical, and they are easy to install and use. They are available in nylon, brass (for copper tubes), steel, and stainless steel. Always match metals, using a steel brush to clean steel tubes, for example. Use stainless steel spiral brushes to clean titanium and copper nickel tubes. Nylon brushes can be used with all tube materials.

Water travels through the flexible Shaft and Casing, providing a flushing action to aid the cleaning process. When the water running out of the tube is clear, the tube is clean.

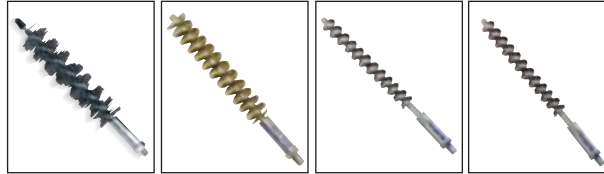

All brushes are available individually or in pkg. of 15 or 25 (depending on brush)

Tube ID Range		Brush Diameter		Nylon Spiral Brush*	Brass Spiral Brush*	Stainless Steel Spiral Brush*	Steel Spiral Brush*	Thread Male (M)
Inches	(mm)	Inches	(mm)					
.281 - .311	(7.1 - 7.9)	1/4	(6.4)	61746-4025	61746-3025	61746-2025	-	8x32 (M)
.312 - .342	(7.9 - 8.7)	9/32	(7.1)	61746-4028	61746-3028	61746-2028	-	
.343 - .374	(8.7 - 9.5)	5/16	(7.9)	61746-4031	61746-3031	61746-2031	-	
.375 - .405	(9.5 - 10.3)	11/32	(8.7)	61746-4034	61746-3034	61746-2034	-	1/4x28 (M)
.406 - .436	(10.3 - 11.1)	3/8	(9.5)	62501-4037	62501-3037	62501-2037	62501-0037	
.437 - .499	(11.1 - 12.7)	7/16	(11.1)	62501-4043	62501-3043	62501-2043	62501-0043	
.500 - .561	(12.7 - 14.2)	1/2	(12.7)	62501-4050	62501-3050	62501-2050	62501-0050	
.562 - .624	(14.2 - 15.8)	9/16	(14.3)	62501-4056	62501-3056	62501-2056	62501-0056	
.625 - .686	(15.8 - 17.4)	5/8	(15.9)	62501-4062	62501-3062	62501-2062	62501-0062	
.687 - .749	(17.4 - 19.0)	11/16	(17.5)	62501-4068	62501-3068	62501-2068	62501-0068	
.750 - .811	(19.0 - 20.6)	3/4	(19.1)	62501-4075	62501-3075	62501-2075	62501-0075	
.812 - .874	(20.6 - 22.2)	13/16	(20.6)	62501-4081	62501-3081	62501-2081	62501-0081	
.875 - .936	(22.2 - 23.8)	7/8	(22.2)	62501-4087	62501-3087	62501-2087	62501-0087	
.937 - .999	(23.8 - 25.4)	15/16	(23.8)	62501-4093	62501-3093	62501-2093	62501-0093	
1.000 - 1.061	(25.4 - 26.9)	1	(25.4)	62501-4100	62501-3100	62501-2100	62501-0100	

## Spin Grit Brushes for Smooth Bore Tubes

Abrasive brush with silicone carbide impregnated nylon recommended for brass tubes. This brush is made oversized, so the filament will lay over, resulting in increased contact with surface, providing better cleaning and longer life than conventional condenser cleaning brushes.



Tube ID Range		Spin Grit Brushes	Brush Diameter	Thread Male (M)
Inches	(mm)			
.250 - .375	(6.3 - 9.5)	62551-0050	.500	8-32(M)
.375 - .500	(9.5 - 12.7)	62551-0062	.625	1/4-28(M)
.500 - .625	(12.7 - 15.9)	62551-0075	.750	
.625 - .812	(15.9 - 20.6)	62551-0100	1.000	
.812 - 1.000	(20.6-25.4)	62551-0125	1.125	

## Spin Clean Brushes for Internally Enhanced Tubes

This abrasive brush is made with a tapered trim to allow cleaning of enhanced condenser tubes. The long bristles are designed oversized with the intention of being bent over, allowing the aggressive filament to come into maximum contact with the lands. The short bristles are able to get into the grooves.



Tube ID Range		Spin Clean Brushes	Small Diameter	Large Diameter	Thread Male (M)
Inches	(mm)				
.500	(12.7)	62615-0075	.500	.750	1/4-28(M)
.625	(15.9)	62615-0100	.625	1.000	
.750	(19.0)	62615-0112	.750	1.125	
1.000	(25.4)	62615-0175	1.000	1.375	

## Buffing Tools

### Applications

- Finish-Up Cleaning of 1/2 - 3 1/2-Inch (12.7 - 88.9mm) Outer Diameter Tubes
- Set of Wires Clean Away Debris after Using Expanding Brush or Expanding Scraper
- Replacement Wire Blades Keep Unit Affordable

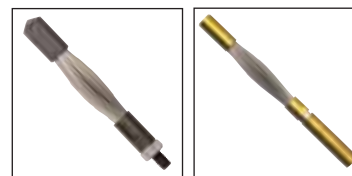

Tube ID Range		Buffing Tool with Tip	Buffing Tool without Tip	Replacement Blades (#)	Drive Thread
Inches	(mm)				
.312-.375	(7.9-9.5)	62622-0005	62624-0005	62623-0006 (18)	8 x 32 (M)
.375-.500	(9.5-12.7)	62622-0006	62624-0006	62623-0008 (18)	1/4 x 28 (M)
.500-.625	(12.7-15.9)	62622-0007	62624-0008		
.625-1.000	(15.9-25.4)	62622-0010	62624-0010	62623-0010 (18)	7/16 x 14 (M)
1.000-3.000	(25.4-76.2)	62626-0000	62625-0000	62625-0001 (20)	

# Flexible Shafts & Casings

**Wils-Away™** Shafts & Casings are available in nylon, Teflon, and steel. Smaller diameter casings are nylon (or Teflon, if they will be run dry), and larger casings are steel. Shafts & Casings **Part No. 9726-XXXX** are designed for bi-direction (forward/reverse) cleaning, such as cleaning enhanced tubes with a Spin Grit or Spin Clean brush.



9720



9722



9724

Tube ID Range <i>Inches</i> <i>(mm)</i>	Flexible Shaft & Casing Length		Flexible Shaft & Casing Part No.*	Casing Material	Shaft & Casing Diameter		Shaft Thread <i>Male (M) or Female (F)</i>	
	<i>Feet</i>	<i>(Meters)</i>			<i>Inches</i>	<i>(mm)</i>		
.281 - .437      (7.1 - 11.1)	15	(4.6)	9720-0015	Nylon	1/4	(6.4)	8	x 32 (F)
	25	(7.6)	9722-0025					
.437 - .625      (11.1 - 15.9)	12	(3.7)	9722-6012	Teflon	3/8	(9.5)		
	35	(10.7)	9722-0035					
	45	(13.7)	9722-0045					
	60	(18.3)	9722-0060					
	25	(7.6)	9724-0025					
.625 - 1.250      (15.9 - 31.8)	35	(10.7)	9724-0035	Nylon	1/2	(12.7)	1/4	x 28 (F)
	45	(13.7)	9724-0045					
	60	(18.3)	9724-0060					
	25	(7.6)	9724-6025					
	25	(7.6)	9726-0025					
.687 - 1.250      (17.5 - 31.8)	35	(10.7)	9726-0035	Nylon	9/16	(14.3)		
	45	(13.7)	9726-0045					
	60	(18.3)	9726-0060					
	25	(7.6)	9726-6025					
	25	(7.6)	9728-0025					
1.250 - 1.500      (31.8 - 38.1)	35	(10.7)	9728-0035	Nylon	3/4	(19.1)		
	45	(13.7)	9728-0045					
	60	(18.3)	9728-0060					
	25	(7.6)	9728-6025					
	25	(7.6)	9730-0025					
1.250 - 4.000      (31.8 - 101.6)	30	(9.1)	9730-0030	Rubber Coated	1 1/8	(27.0)		
	25	(7.6)	9732-0025	Steel				
	30	(9.1)	9732-0030	Rubber Coated				
4.000 - 4.250      (101.6 - 108.0)	25	(7.6)	9732-0025	Steel	1 1/4	(31.8)	3/4	x 10 (M)
	30	(9.1)	9732-0030					

\* To order Shafts & Casings with **Wilson Smart Connect™** adapters, add **"WC"** to **Part No.**  
Maximum operating temperature: nylon 212°F, teflon 500°F.

## Wils-Away™ Accessories



**Twin Foot Pedal** provides forward (clockwise) and reverse (counter clockwise) brush rotation for effective cleaning of enhanced tubes.

**Part No.**

9600-0015



**Safety Shaft Coupling** prevents motor damage to **WAW-500** series drive units. These drive units are shipped with a spare Safety Shaft Coupling and a removal tool.

9600-0102



**Flexible Shaft Lubricator** provides lubrication to Shaft & Casing Assembly, prolonging its life.

9675-0000



**Steel Shaft  
9730-0025**



**Steel with Rubber Coating  
9730-9025**



# Cleaning Heads

## Boiler Steel Spiral Brushes



Tube ID Range		Steel Spiral Brush*	Stainless Steel Spiral Brush*	Brass Spiral Brush*	Nylon Spiral Brush*	Thread*
Inches	(mm)					Male (M)
1.250 - 1.400	(31.8 - 38.1)	62540-0125	62540-2125	62540-3125	62540-4125	1/4 NPT (M)
1.500 - 1.749	(38.1 - 44.4)	62540-0150	62540-2150	62540-3150	62540-4150	
1.750 - 1.999	(44.5 - 50.8)	62540-0175	62540-2175	62540-3175	62540-4175	
2.000 - 2.249	(50.8 - 57.1)	62540-0200	62540-2200	62540-3200	62540-4200	
2.250 - 2.499	(57.2 - 63.5)	62540-0225	62540-2225	62540-3225	62540-4225	
2.500 - 2.749	(63.5 - 69.8)	62540-0250	62540-2250	62540-3250	62540-4250	
2.750 - 2.999	(69.9 - 76.1)	62540-0275	62540-2275	62540-3275	62540-4275	
3.000 - 3.249	(76.2 - 82.5)	62540-0300	62540-2300	62540-3300	62540-4300	
3.250 - 3.349	(82.6 - 88.9)	62540-0325	62540-2325	62540-3325	62540-4325	
3.500 - 3.749	(88.9 - 95.2)	62540-0350	62540-2350	62540-3350	62540-4350	
3.750 - 3.999	(95.3 - 101.6)	62540-0375	62540-2375	62540-3375	62540-4375	
4.000 - 4.250	(101.6 - 108.0)	62540-0400	62540-2400	62540-3400	62540-4400	

\* Requires adapter #9893 (9/16"-12F x 1/4" NPT), #9894 (3/4"-10F x 1/4" NPT), #9891 7/16"-14F x 1/4" NPT)

## Soot Brush

### Applications

- Removing Soot from 1½ to 4½-Inch (38.1 to 114.3mm) Outer Diameter Tubes in Fire Tube Boilers
- Attaches to Competing Drive Units

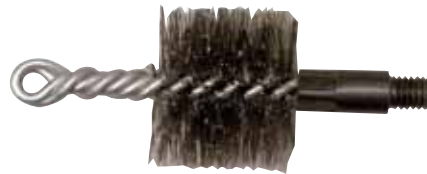

Tube ID Range		Steel Soot Brush	Thread
Inches	(mm)		Male (M)
1.250 - 1.499	(31.8 - 38.1)	62711-0125	1/2 x 12 (M)
1.500 - 1.749	(38.1 - 44.4)	62711-0150	
1.750 - 2.249	(44.5 - 57.1)	62711-0175	
2.225 - 2.749	(57.2 - 69.8)	62711-0225	
2.750 - 2.999	(69.9 - 76.2)	62711-0275	
3.000 - 3.249	(76.2 - 82.5)	62711-0300	
3.250 - 3.749	(82.6 - 95.2)	62711-0325	
3.750 - 4.250	(95.3 - 108.0)	62711-0375	

## U-Bend Cleaning Assemblies

### Applications

- Cleaning 3/4 to 1½-Inch (19.1 to 38.1mm) Outer Diameter Curved Tubes
- Use Stainless Steel Assembly to Clean Ferrous Tubes, Brass Cleaning Head for Nonferrous Tubes

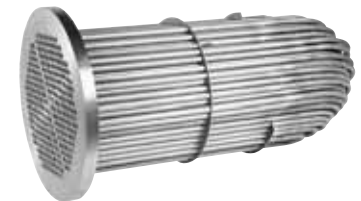
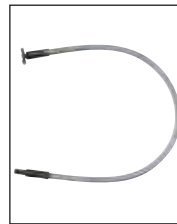

U-Bend Heat Exchanger Bundle

Tube ID Range		Assembly with Stainless Steel Cleaning Head	Assembly with Brass Cleaning Head	Cleaning Head Type	Diameter	Drive Thread
Inches	(mm)				(Inches) (mm)	
.500 - .750	(12.7 - 19.1)	62690-0000	62690-5000	Cup Brush	3/4 (19.1)	1/4 x 28 (M)
.750 - 1.000	(19.1 - 25.4)	62660-0075	62660-1075	Wheel Brush		
1.000 - 1.250	(25.4 - 31.8)	62660-0100	62660-1100			

## Manual Tube Cleaning Extension Rods and Handles



Tube ID Range		Handle Part No.	Extension Rods Part No. (#)	Length Feet (M)
Inches	(mm)			
.160 - .250	(4.0 - 6.3)	62785-0001 (2 feet)	62785-0002 (2) (Steel with 3-48 Female Thread)	2 (0.6)
.250 - .375	(6.3 - 9.5)	62784-0001 (2 feet)	62784-0002 (2) (Steel with 8-32 Female Thread)	2 (0.6)
.375 - .500	(9.5 - 12.7)	62744	62743 (6) (Steel with 8-32 Female Thread)	2 (0.6)
.500 - 1.061	(12.7 - 26.9)	62741	62742 (6) (Steel with 1/4x28 Female Thread)	3 (0.9)
1.250 - 2.999	(31.8- 76.1)	62756	62748 (6)	3 (0.9)
			62749 (6)	4 (1.2)
			62750 (6) (Fiberglass with 1/4" NPT Female)	6 (1.8)
3.000 - 4.250	(76.2- 108.0)	62757	62751† (6)	4 (0.9)
			62752† (6)	5 (1.2)
			62753† (6) (Fiberglass with 3/8" NPT Female)	6 (1.8)

†For 3/8 NPT to 1/4 NPT Adapter use Part No. 6701

# Expanding Brush and Expanding Scraper

The **Wilson Expanding Scraper** and the **Wilson Expanding Brush** work together and are recommended for removing soft, wet, or gummy deposits such as marine growth.

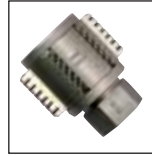
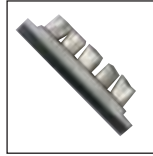

Tube ID Range Inches (mm)	Expanding Brush* Assembly	Cleaning Range Inches	Brush Refill Set* Part No. (#)	Expanding Scraper Assembly	Cleaning Ranges Inches	Scraper Refill Set Part No. (#)	Thread Male (M) or Female (F)	
.482 - .495 (12.2 - 12.6)	7000-0001	.453 - .487	7003-0001 (4)	2569	.437 - .625	2574 (4)	12 x 28 (M)	
.496 - .527 (12.6 - 13.4)	7000-0002	.485 - .519	7003-0002 (4)					
.528 - .555 (13.4 - 14.1)	7000-0003	.518 - .552	7003-0003 (4)					
.556 - .584 (14.1 - 14.8)	7000-0004	.542 - .576	7003-0004 (4)					
.585 - .620 (14.8 - 15.7)	7000-0005	.578 - .612	7003-0005 (4)	2575				
.621 - .652 (15.7 - 16.6)	7000-0006	.610 - .644	7003-0006 (4)					
.653 - .680 (16.6 - 17.3)	7000-0007	.638 - .672	7003-0007 (4)					
.528 - .555 (13.4 - 14.1)	9900-0003	.518 - .552	7003-0003 (4)					
.556 - .584 (14.1 - 14.8)	9900-0004	.542 - .576	7003-0004 (4)	2549	.500-.687	2577 (4)		1/4 x 28 (M)
.585 - .620 (14.8 - 15.7)	9900-0005	.578 - .612	7003-0005 (4)					
.621 - .652 (15.7 - 16.6)	9900-0006	.610 - .644	7003-0006 (4)					
.653 - .680 (16.6 - 17.3)	9900-0007	.638 - .672	7003-0007 (4)					
.681 - .709 (17.3 - 18.0)	2456-0001	.611 - .752	2457-0001 (4)	3055	.687 - .781	3058 (4)	5/16x 18 (M)	
.710 - .745 (18.0 - 18.9)	2456-0002	.661 - .802	2457-0002 (4)					
.746 - .777 (18.9 - 19.7)	2456-0003	.689 - .830	2457-0003 (4)	2578	.719 - .875	2582 (4)		
.778 - .870 (19.7 - 22.1)	2456-0004	.764 - .905	2457-0004 (4)					
.871 - .907 (22.1 - 23.0)	2456-0005	.786 - .927	2457-0005 (4)	2586	.797 - .953	2582 (4)		
.908 - .959 (23.0 - 24.4)	2456-0006	.838 - .979	2457-0006 (4)					
.960 - .995 (24.4 - 25.3)	2456-0007	.874 - 1.015	2457-0007 (4)	2592	.891 - 1.109	2596 (4)		
.996 - 1.032 (25.3 - 26.2)	2463-0004	.894 - 1.052	2464-0004 (4)					
1.033 - 1.084 (26.2 - 27.5)	2463-0005	.946 - 1.104	2464-0005 (4)					
1.085 - 1.120 (27.5 - 28.4)	2463-0007	.996 - 1.155	2464-0007 (4)					
1.121 - 1.245 (28.4 - 31.6)	2463-0009	1.106 - 1.265	2464-0009 (4)	2600	1.000 - 1.218	2601 (4)		
1.246 - 1.310 (31.6 - 33.3)	2470-0003	1.176 - 1.377	2471-0003 (6)					
1.252 - 1.300 (31.8 - 33.0)	2477-0001	1.170 - 1.330	2478-0001 (6)	2606	1.141 - 1.359	2610 (4)		
1.311 - 1.356 (33.3 - 34.4)	2470-0004	1.216 - 1.376	2471-0004 (6)					
1.301 - 1.482 (34.4 - 37.6)	2477-0004	1.300 - 1.501	2478-0004 (6)	2617	1.328 - 1.593	2621 (4)		
	2477-9004							
	2477-0006	1.426 - 1.626	2478-0006 (6)					
	2477-9006							
1.483 - 1.606 (37.6 - 40.8)	2484-0003	1.493 - 1.724	2485-0003 (8)	2634	1.437 - 1.891	2639 (6)	7/16x14 (M)	
1.607 - 1.704 (40.8 - 43.3)	2484-0006	1.623 - 1.854	2485-0006 (8)					
1.705 - 1.760 (43.3 - 44.7)	2492-0006	1.712 - 1.946	2485-0003 (8)	2043	1.625 - 2.093	4115 (6)	7/16x14 (M)	
1.761 - 1890 (44.7 - 48.0)	2493-0003							
1.891 - 1.954 (48.0 - 49.6)	2493-0005	1.780 - 2.014	2485-0005 (8)					
1.955 - 2.084 (49.6 - 52.9)	2493-0007	1.910 - 2.144	2485-0007 (8)					
2.000 - 2.124 (50.8 - 54.0)	3441-0001	1.834 - 2.279	3445-0001 (6)	7985-2416	1.750 - 2.250	7997 (5)	9/16x12 (F)	
	3442-0001							
	2494-0007							
	3441-0003							
2.125 - 2.249 (54.0 - 57.1)	3442-0003	1.896 - 2.341	3445-0003 (6)	7986-2416	1.875 - 2.375	8008 (5)	5/8x11 (F)	
	3444-0003							
	3441-0005			7987-2416	2.000 - 2.500	8009 (5)	9/16x12 (F)	
2.250 - 2.374 (57.1 - 60.3)	3442-0005	1.998 - 2.443	3445-0005 (6)					
	3444-0005							
	3441-0008							
2.375 - 2.499 (60.3 - 63.5)	3442-0008	2.146 - 2.591	3445-0008 (6)	7988-2416	2.125 - 2.625	8010 (5)	5/8x11 (F)	
	3441-0010							
2.500 - 2.624 (63.5 - 66.6)	3442-0010	2.248 - 2.693	3445-0010 (6)	7989-3073	2.187 - 2.812	8009 (6)	9/16x12 (F)	
	3444-0010							
2.625 - 2.749 (66.6 - 69.8)	3456-0002	2.417 - 2.825	3458-0002 (6)	7990-2354	2.312 - 2.937	8010 (6)	5/8x11 (F)	
	3457-0002							
2.750 - 2.874 (69.8 - 73.0)	3456-0003	2.605 - 3.013	3458-0003 (6)	7991-3077	2.375 - 3.125	8016 (5)	3/4x10 (F)	
	3457-0003							
2.875 - 2.999 (73.0 - 76.2)	3456-0004	2.667 - 3.075	3458-0004 (6)	7991-3077	2.375 - 3.125	8016 (5)	7/8x9 (F)	
	3457-0004							
	3470-0002			7992-3080	2.625 - 3.375	8019 (6)	3/4x10 (F)	
3.000 - 3.124 (76.2 - 79.3)	3471-0002	2.782 - 3.233	3473-0002 (6)					
	3471-9002							

\* To order Bronze Expanding Brushes Bronze Refill Sets, change second half of (Part No. to "3XXX"). For Nylon, change second half of (Part No. to "4XXX"). For Stainless steel, ("5XXX"). Expanding Brushes with ("900X") and "2XXX" Part Nos. have Steel Brushes and special Adapters.

## 3 Roll Condenser Expanders

**Series**  
41, 44,  
47-C

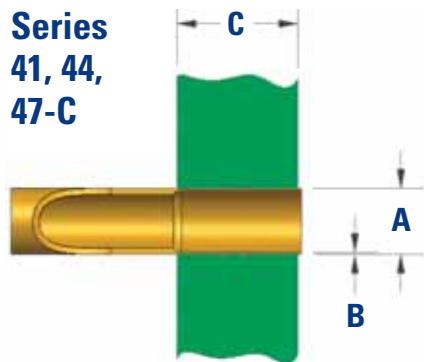

**A** = 1/2 (12.7mm) to 1½-Inch (38.1mm) Tube Outer Diameter

**B** = 9 (3.8mm) to 22 (.7mm) Gauge

**C** = 41-C - 1/2 (12.7mm) to 1½-Inch (38.1mm) Tubesheet

44-C - 1¼ (31.8mm) to 6-Inch (152.4mm) Tubesheet

47-C - 1¼ (38.1mm) to 12-Inch (304.8mm) Tubesheet



How to identify Wilson Rolls

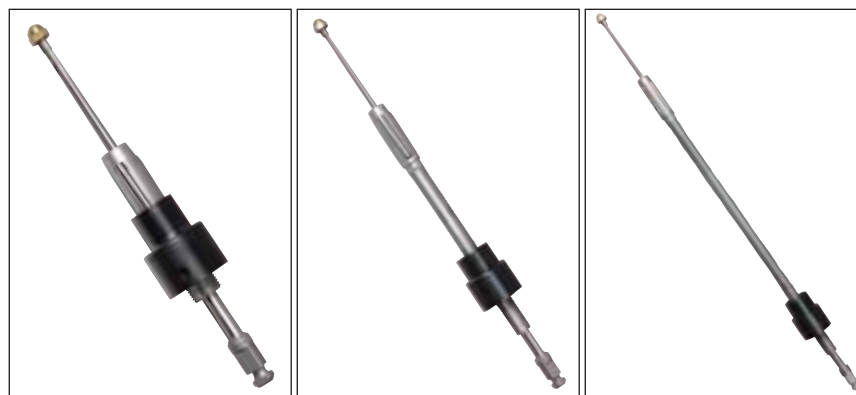

1½" (38.1)  
Roll  
Length  
Common  
Roll Set  
Part No.

Tube		Range		41-C Expander			44-C Expander			47-C Expander			Common Roll Set Part No.					
OD Inches (mm)	GA	Inches	(mm)	Assembly	Mandrel	Cage	Assembly	Mandrel	Cage	Assembly	Mandrel	Cage						
1/2 (12.7)	14	.320-.370	(8.1-9.4)	34043	33454	34322	34143	33455	39739	-	-	-	33371					
	15	.342-.390	(8.7-9.9)	34042		34320	34142		39740	-	-	-	-	33360				
	16-17	.360-.411	(9.1-10.4)	34000	33400	33040	34100	33430	33240	-	-	-	33361					
	18-19	.392-.447	(10.0-11.4)	34001		33041	34101		33241	41597	38567	38566						
	20-22	.425-.481	(10.5-12.2)	40582		41866	33042		34102	41867	33242	41598		41868	38568			
5/8 (15.9)	12	.392-.447	(10.0-11.4)	39366	41866	33041	39369	41867	33241	39445	38567	38566		33362				
	13	.425-.481	(10.5-12.2)	34051		33042	34099		33242	38554	41868	38568						
	14	.444-.513	(11.3-13.0)	41034		33043	41393		33243	41397		38569	33362					
	15-17	.464-.537	(11.8-13.6)	38388		38619	38396		38623	39447		39448	33375					
	18-19	.497-.571	(12.6-14.5)	38394		39807	38392		39549	39449		39450	33376					
	20-22	.542-.600	(13.8-15.2)	40585		41531	33046		39593	41548	33246	39607	41550		38571	33364		
3/4 (19.1)	10	.444-.513	(11.3-13.0)	34003	41866	33043	34103	41867	33243	38555	41868	38569	33362					
	11	.482-.550	(12.2-14.0)	34004		33044	34104		33244	38575		38576	33363					
	12	.508-.583	(12.9-14.8)	34005		33402	33045		34105	33432		33245	38556	33932	38570	33364		
	13-14	.542-.625	(13.8-15.9)	34006			33046		34106			33246	38557	38571	33365			
	15-17	.589-.681	(15.0-17.3)	34008			33403		33048			34108	33433	33248	38579	33933	38580	33365
	18-22	.635-.722	(16.1-18.3)	34009			33404		33049			34109	33434	33249	39453	33934	39454	33366
7/8 (22.2)	11	.589-.681	(15.0-17.3)	34008	33403	33048	34108	33433	33248	38579	33933	38580	33366					
	12-13	.635-.722	(16.1-18.3)	34010	33404	33049	34110	33434	33249	39456	33934	39454						
	14-15	.686-.781	(17.4-19.8)	34011	33405	33051	34111	33435	33251	39457	33935	39458						
	16-17	.717-.815	(18.2-20.7)	34013	33407	33053	34113	33437	33253	39461	33937	39462		33367				
	18-22	.758-.855	(19.3-21.7)	34015	33406	33055	34115	33436	33255	39465	33936	39466		33367				
1 (25.4)	9	.686-.781	(17.4-19.8)	34011	33405	33051	34111	33435	33251	39457	33935	39458	33366					
	10	.701-.800	(17.8-20.3)	34012	33406	33052	34112	33436	33252	39459	33936	39460						
	11	.717-.815	(18.2-20.7)	34013	33407	33053	34113	33437	33253	39461	33937	39462						
	12-13	.758-.855	(19.3-21.7)	34015	33406	33055	34115	33436	33255	39465	33936	39466		33367				
	14-16	.794-.919	(20.2-23.3)	34018	33408	33058	34118	33438	33258	39469	33938	39470		33368				
	17-22	.856-.980	(21.7-24.9)	40579	33411	33062	41399	33441	33262	41403	33941	38611		33369				
	9-10	.794-.919	(20.2-23.3)	41869	33408	33058	42326	33438	33258	-	-	-		33368				
1½ (38.1)	11-14	.856-.999	(21.7-25.4)	34022	33411	33062	34122	33441	33262	-	-	-	33369					
	15-22	.950-1.106	(24.1-28.1)	41014	41012	33067	41405	41013	33267	-	-	-	33370					
	9-11	.920-1.076	(23.4-27.3)	34025	33412	33065	34125	33442	33265	39481	33942	39482	33370					
	12-13	.950-1.106	(24.1-28.1)	34027	33414	33067	34127	33444	33267	39485	33944	39486	33371					
1 (31.8)	14-22	1.055-1.235	(26.8-31.4)	40588	33415	33071	41407	33445	33271	41864	33945	39492	33372					
	10-13	1.055-1.250	(26.8-31.8)	34031		33071	34131		-	-	-	-	-	33372				
	14-20	1.185-1.350	(30.1-34.3)	40589		33074	41409		-	-	-	-	-	33373				
1 (34.9)	10-13	1.185-1.375	(30.1-34.9)	34034	33415	33074	34134	33445	33274	39497	33945	39498	33373					
	14-18	1.310-1.460	(33.3-37.1)	34037		33416	33077		34137	33446	33277	39503	33946	39504	33374			



**Series  
41, 44,  
47-D**

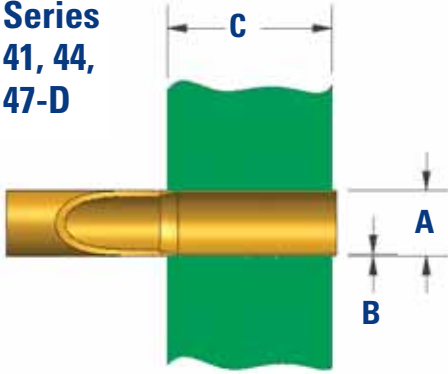

**A** = 1/2 (12.7mm) to 2 1/2-Inch (63.5mm) Tube Outer Diameter

**B** = 9 (3.8mm) to 22 (.7mm) Gauge

**C** = 41-D - 1 1/4 (31.8mm) to 2 1/4-Inch (57.2mm) Tubesheet  
 44-D - 2 (50.8mm) to 6 3/4-Inch (171.5mm) Tubesheet  
 47-D - 2 (50.8mm) to 12 3/4-Inch (323.9mm) Tubesheet



2 1/4" (57.2)  
Roll  
Length  
Common  
Roll Set  
Part No

Tube		Range		41-D Expander			44-D Expander			47-D Expander			Roll Set Part No			
Inches	OD (mm)	GA	Inches	mm	Assembly	Mandrel	Cage	Assembly	Mandrel	Cage	Assembly	Mandrel		Cage		
1/2	(12.7)	18-19	.392-.447	(10.0-11.4)	39734	33400	39368	41414	33430	39371	41601	38567	39506	33381		
		20-22	.425-.481	(10.5-12.2)	40616	33401	33184	41415	33431	33456	41602	33931	33852			
5/8	(15.9)	12	.392-.447	(10.0-11.4)	39367	33400	39368	39370	33430	39371	39505	38567	39506		33382	
		13	.425-.481	(10.5-12.2)	34052		33184	34152		33456	33802		33852			
		14	.444-.513	(11.3-13.0)	41035	33401	33133	41394	33431	33323	41398	33931	33853			33382
		15-17	.464-.537	(11.8-13.6)	38389		38621	38397		38624	38627		38628			33377
		18-19	.497-.571	(12.6-14.5)	38395		39805	38393		39554	39507		39508			33398
		20-22	.542-.600	(13.8-15.2)	40591	41531	33136	39597	41548	33326	39610	41550	33856			33384
3/4	(19.1)	10	.444-.513	(11.3-13.0)	34053	33401	33133	34153		33323	33803		33853		33382	
		11	.482-.550	(12.2-14.0)	34054		33134	34154	33431	33324	33804	33931	33854			
		12	.508-.583	(12.9-14.8)	34055	33402	33135	34155		33432	33325		33805			33932
		13-14	.542-.625	(13.8-15.9)	34056		33136	34156			33326	33806				
		15-17	.589-.681	(15.0-17.3)	34058	33403	33138	34158	33433	33328	33808	33933	33858	33385		
		18-22	.635-.722	(16.1-18.3)	34059	33404	33139	34160	33434	33329	33810	33934	33859			
7/8	(22.2)	11	.589-.681	(15.0-17.3)	34058	33403	33138	34158	33433	33328	33808	33933	33858	33386		
		12-13	.635-.722	(16.1-18.3)	34060	33404	33139	34160	33434	33329	33810	33934	33859			
		14-15	.686-.781	(17.4-19.8)	34061	33405	33141	34161	33435	33331	33811	33935	33861			
		16-17	.717-.815	(18.2-20.7)	34063	33407	33143	34163	33437	33333	33813	33937	33863			
1	(25.4)	18-22	.758-.855	(19.3-21.7)	34065	33406	33145	34165	33436	33335	33815	33936	33865	33387		
		9	.686-.781	(17.4-19.8)	34061	33405	33141	34161	33435	33331	33811	33935	33861			
		10	.701-.800	(17.8-20.3)	34062	33406	33142	34162	33436	33332	33812	33936	33862			
		11	.717-.815	(18.2-20.7)	34063	33407	33143	34163	33437	33333	33813	33937	33863			
		12-13	.758-.855	(19.3-21.7)	34065	33406	33145	34165	33436	33335	33815	33936	33865			
		14-16	.794-.919	(20.2-23.3)	34068	33408	33148	34168	33438	33338	33818	33938	33868			
1 1/8	(28.6)	17-22	.856-.980	(21.7-24.9)	40592	33411	33152	41400	33441	33342	41404	33941	33872	33389		
		9-10	.794-.919	(20.2-23.3)	41870	33408	33148	42327	33438	33338	-	-	-			
		11-14	.856-.999	(21.7-25.4)	34072	33411	33152	34172	33441	33342	-	-	-			
1 1/4	(31.8)	15-22	.950-1.106	(24.1-28.1)	41015	41012	33157	41406	41013	33347	-	-	-	33390		
		9-11	.920-1.076	(23.4-27.3)	34075	33412	33155	34175	33442	33345	33825	33942	33875			
		12-13	.950-1.106	(24.1-28.1)	34077	33414	33157	34177	33444	33347	33827	33944	33877			
1 1/2	(34.9)	14-22	1.055-1.235	(26.8-31.4)	40593		33161	41408		33351	41865	33945	33881	33392		
		10-13	1.055-1.250	(26.8-31.8)	34081	33415		34181	33445		-	-	-			
1 3/4	(38.1)	14-20	1.185-1.350	(30.1-34.3)	40594			33164		41410		33354	-	-	-	33393
		10-13	1.185-1.375	(30.1-34.9)	34084			34184		33354	33834	33945	33884			
2	(50.8)	14-18	1.310-1.460	(33.3-37.1)	34087	33416	33167	34187	33446	33357	33837	33946	33887	33394		
		8-13	1.372-1.620	(34.8-41.1)	34089		33169	34310		33359	-	-	-			
2 1/4	(57.2)	14-18	1.495-1.710	(38.0-43.4)	40595	33419	33171	41412	33449	33425	-	-	-	33395		
		7-8	1.495-1.744	(38.0-44.3)	34091			34312			-	-	-		-	
2 1/2	(63.5)	9-11	1.630-1.876	(41.4-47.7)	34093		33173	34314		33322	-	-	-	33396		
		12-18	1.753-1.972	(44.5-50.1)	34095	33422	33175	34316	33452	33183	-	-	-			
10-18	1.926-2.213	(48.9-56.2)	34096		33176		34317			33427	-	-	-	33397		
10-18	2.176-2.462	(55.3-62.5)	34097	33423	33177	34318	33453	33428	-	-	-	-				

# Expander Series

## 4 & 5 Roll Condenser Expanders - 1/2" - 6 1/4" Tubesheets

Series  
72, 73-C

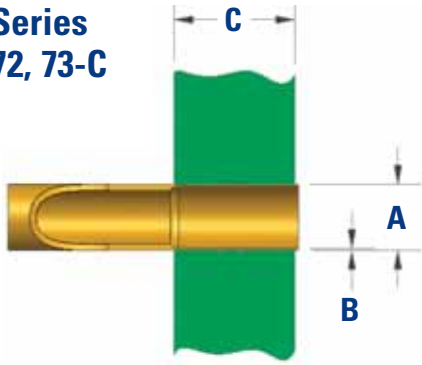

**A** = 1/2 (12.7mm) to 1 1/2-Inch (38.1mm) Tube Outer Diameter  
**B** = 13 (2.4mm) to 25 (.5mm) Gauge  
**C** = 72-C - 1/2 (12.7mm) to 1 1/2-Inch (38.1mm) Tubesheet  
 73-C - 3/4 (19.1mm) to 5 1/2-Inch (139.7mm) Tubesheet



Tube		Range		72-C Expander 1/2-1 1/2" Reach			73-C Expander 3/4-5 1/2" Reach			1 1/2" (38.1) Roll Length Common Roll Set - Part No.
OD	Wall	Range		Assembly	Mandrel	Cage	Assembly	Mandrel	Cage	
Inches (mm)	GA	Inches	(mm)	Part No.	Part No.	Part No.	Part No.	Part No.	Part No.	
1/2 (12.7)	18-19	.387-.449	(9.8-11.4)	41552	41879	41511	-	-	-	33361-4
	20-25	.425-.480	(10.5-12.2)	41553	41880	41512	-	-	-	
5/8 (15.9)	18-19	.515-.570	(13.1-14.5)	41554	41881	41513	41936	42064	42000	33362-4
	20-25	.537-.596	(13.6-15.1)	41555		41514	41937		42001	33375-4
3/4 (19.1)	13-14	.537-.596	(13.6-15.1)	41556	41882	41515	42331	42066	42002	33363-5
	16-17	.605-.676	(15.2-17.2)	41557			41938		42003	
	18-19	.635-.715	(16.1-18.2)	41558			41939		42004	
	20-25	.665-.750	(16.9-19.1)	41559			41940		42005	
7/8 (22.2)	16-17	.717-.795	(18.2-20.2)	41560	41884	41518	41941	42067	42006	33365-5
	18-19	.758-.859	(19.3-21.9)	41561	41885	41519	41942	42069	42006	
1 (25.4)	20-25	.790-.885	(20.1-22.5)	41562	41886	41520	41943		42070	42007
	13-15	.790-.885	(20.1-22.5)	41563	41887	41521	42332	42008		
	16-17	.850-.922	(21.6-23.4)	41564			41944	42009		
	18-19	.885-.950	(22.5-24.1)	41565			41945	42010		
20-25	.915-1.015	(23.2-25.8)	41566	41946			42011			
1 1/8 (28.6)	18-19	1.010-1.075	(25.7-27.3)	41567	41889	41524	41947	42071	42012	33367-5
	20-25	1.040-1.125	(26.4-28.6)	41568	41890	41528	41948		42011	
1 1/4 (31.8)	18-19	1.135-1.200	(28.8-30.5)	41569	41891	41530	41949	42072	42012	33370-5
	20-25	1.165-1.250	(29.6-31.8)	41570	41892	41532	41949		42013	
1 1/2 (38.1)	18-19	1.385-1.450	(35.2-36.8)	41571	41893	41533	41950	42073	42014	33372-5
	20-25	1.415-1.500	(35.9-38.1)	41572	41893	41534	41951	42074	42015	

### Thin Gauge Collar

Thin Gauge Collar assembly supplied on all 5-roll, 72 & 73 Series, 20-23 Gauge Expanders. Recess adjustable by use of space washers. Unique design maintains tube end contact throughout expansion.

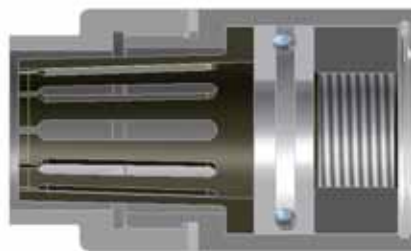

### TUBE WALL THICKNESS OF WALL IN BIRMINGHAM WIRE GAUGE

GA	28	27	26	25	24	23	22	21	20	19	18	17	16	15	14	13	12	11	10	9	8	7	6
Inch	.014	.016	.018	.020	.022	.025	.028	.032	.035	.042	.049	.058	.065	.072	.083	.095	.109	.120	.134	.148	.165	.180	.203
mm	.4	.4	.5	.5	.6	.6	.7	.8	.9	1.1	1.2	1.5	1.7	1.8	2.1	2.4	2.8	3.0	3.4	3.8	4.2	4.6	5.2

**Series  
72, 73-D**

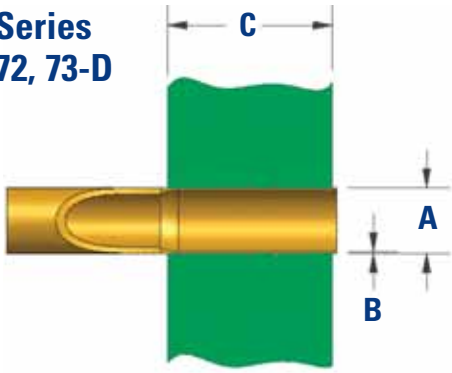

**A** = 1/2 (12.7mm) to 1½-Inch (38.1mm) Tube Outer Diameter  
**B** = 13 (2.4mm) to 25 (.5mm) Gauge  
**C** = 72-D - 1/2 (12.7mm) to 2¼-Inch (57.2mm) Tubesheet  
 73-D - 1½ (38.1mm) to 6¼-Inch (158.8mm) Tubesheet



Tube		Range		72-D Expander 1/2-2¼" Reach			73-D Expander 1½-6¼" Reach			2¼" (57.2) Roll Length Common Roll Set - Part No.			
OD Inches (mm)	Wall GA	Inches	(mm)	Assembly Part No.	Mandrel Part No.	Cage Part No.	Assembly Part No.	Mandrel Part No.	Cage Part No.				
1/2 (12.7)	18-19	.387-.449	(9.8-11.4)	42248	42286	42267	-	-	-	33380-4			
	20-25	.425-.480	(10.5-12.2)	42249	42287	42268	-	-	-				
5/8 (15.9)	18-19	.515-.570	(13.1-14.5)	42250	42288	42269	41952	42064	42016	33382-4			
	20-25	.537-.596	(13.6-15.1)	42251		42270	41953		42017				
3/4 (19.1)	13-14	.537-.596	(13.6-15.1)	42329	42289	42271	42333	42066	42018	33383-5			
	16-17	.605-.676	(15.2-17.2)	42252			42272				41954		
	18-19	.635-.715	(16.1-18.2)	42253			42273				41955		
	20-25	.665-.750	(16.9-19.1)	42254			42290				41956	42067	42020
7/8 (22.2)	16-17	.717-.795	(18.2-20.2)	42255	42291	42275	42274	42069	42021	33385-5			
	18-19	.758-.859	(19.3-21.9)	42256			42276		41958		42022		
1 (25.4)	20-25	.790-.885	(20.1-22.5)	42257	42293	42279	42277	42071	42023	33386-5			
	13-15	.790-.885	(20.1-22.5)	42330			42278		41959		42024		
	16-17	.850-.922	(21.6-23.4)	42258			42292		42277		41960	42070	42025
	18-19	.885-.950	(22.5-24.1)	42259			42278		41961		42025		
1¼ (28.6)	20-25	.915-1.015	(23.2-25.8)	42260	42294	42280	42304	42072	42308	33387-5			
	18-19	1.010-1.075	(25.7-27.3)	42261			42281		41962		42026		
1½ (31.8)	20-25	1.040-1.125	(26.4-28.6)	42262	42295	42282	42281	42073	42027	33389-5			
	18-19	1.135-1.200	(28.8-30.5)	42263			42282		41964		42028		
1¾ (38.1)	20-25	1.165-1.250	(29.6-31.8)	42264	42296	42283	41965	42074	42029	33390-5			
	18-19	1.385-1.450	(35.2-36.8)	42265			42284		41966		42030		
1½ (38.1)	20-25	1.415-1.500	(35.9-38.1)	42266	42297	42285	41967	42075	42031	33392-5			

**Expander Lube - Type B**

**Wilson Expander Lube** is a water-soluble lubricant especially compounded for use with tube expanders. When rolling large or small, ferrous or nonferrous tubes, use **Wilson Expander Lube** for smoother rolling and longer expander life. For clean tube ends after rolling, simply wash with water. **Wilson Type B** Expander Lube is used straight from the can without dilution.



Expander Lube Type B	Part No.
1-Quart Can	28115-0002
1-Gallon Can	28115-0009
5-Gallon Can	28115-0005
30-Gallon Drum	28115-0030
55-Gallon Drum	28115-0055



# Wilson Torq-Air-Matic™ Expander Drives

## Reversible, Muffled, Controlled Tube Expansion



3A - Torq-Air-Matic™ Kit



B - Torq-Air-Matic™ Kit

### Applications

- Rolling ferrous and nonferrous tubes in heat exchangers and other pressure vessels
- 1/2 to 1 1/2-Inch (12.7 to 38.1mm) Outer Diameter Tubes

### Specifications

#### • 3A Torq-Air-Matic™ Kit

- Weight: Drive: 9 lbs. (4 Kg) Kit: 21 lbs. (9.5 Kg)
- Air Consumption: 32 SCFM Maximum
- Length: 9.5 Inches (241 mm)
- Side to Center: 2 Inches (50.8 mm)
- Drive: 1/2-Inch Ball Drive Spindle

#### • B Torq-Air-Matic™ Kit

- Weight: Drive: 14.5 lbs. (6.6 Kg) Kit: 30.5 lbs. (13.8 Kg)
- Air Consumption: 60 SCFM Maximum
- Length: 12 Inches (305 mm)
- Side to Center: 2 Inches (50.8 mm)
- Drive: 1/2-Inch Spindle Square

### Torq-Air-Matic™ Kit Includes:

- Torq-Air-Matic Drive
- Set of Rotor Blades
- Operating Hose
- Mandrel Connector
- Air Line Filter
- 1 Quart Expander Lube
- Hex Keys
- Carrying Case
- Service Manual



Model	Tube Capacities	Torq-Air-Matic Kit Part No.	Free Speed RPM	Maximum Torque		Minimum Torque	
				Ft. Lbs.	Nm	Ft. Lbs.	Nm
3A	1/2-Inch to 7/8-Inch x 18 ga. nonferrous	40509	1000	10	13.6	3	4
	1/2-Inch to 3/4-Inch ferrous						
	1/2-Inch to 1-Inch nonferrous	40510	750	12	16.3	3	4
	1/2-Inch to 3/4-Inch ferrous						
	1/2-Inch to 1 1/4-Inch nonferrous	40511	450	18	24.4	3	4
1/2-Inch to 1-Inch ferrous							
B	3/4-Inch to 1-Inch OD Tubes	40515	750	24	33	3	4
	3/4-Inch to 1 1/2-Inch OD Tubes	40516	600	30	41	3	4
	3/4-Inch to 1 1/2-Inch OD Tubes	40517	450	40	54	3	4

\* Other Drives Available — Consult Factory

# Wils-Tronic™ Tube Roller

The most important feature of the **Wils-Tronic™** is its ability to maintain constant speed during the entire rolling process, even at various torque settings, making it faster and more efficient than conventional tube rollers. It also runs much quieter than any other tool on the market.

### Performance Data - Low Torque

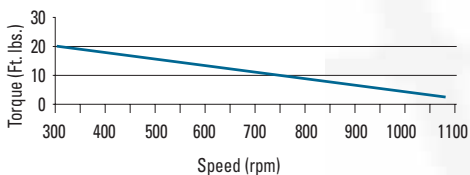

### Performance Data - Mid Torque

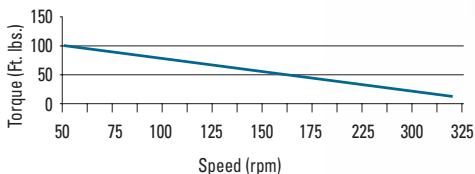

3-phase asynchronous drive motor has an extremely flat torque curve. Tube rolling rpm is determined by desired output torque and preprogrammed into the Wils-Tronic™. Vector drive technology will maintain that rpm throughout the rolling process.

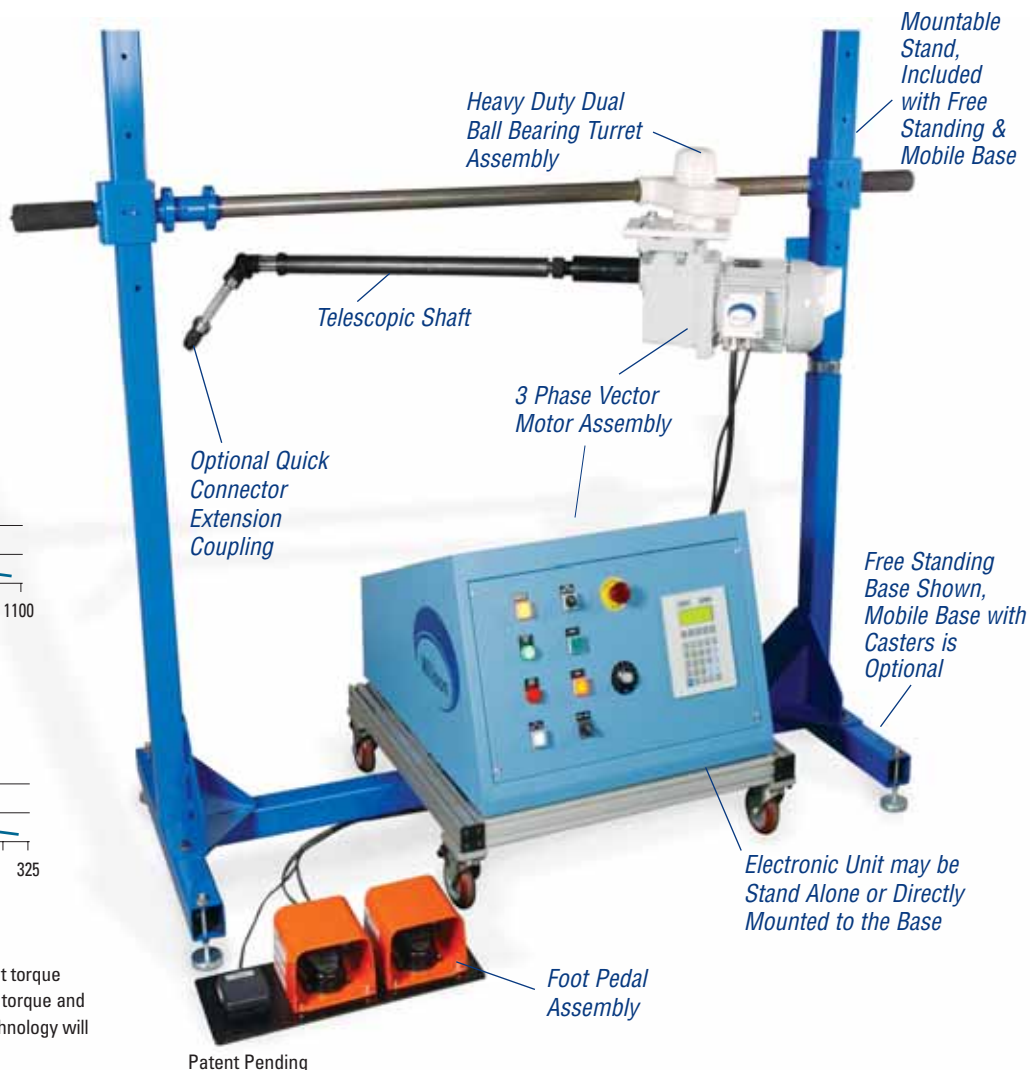

Patent Pending

## How to Order

Wils-Tronic™ Model	Low Torque	Mid Torque	High Torque
<b>Technical Data</b>			
Tube Capacity	1/2 to 1½-Inch Tubes	3/4 to 3-Inch Tubes	Up to 3-Inch Tubes
rpm	0-1400 RPM	0-400 RPM	0-400 RPM
Torque Ranges	1-30 Ft-lbs.	15-120 Ft-lbs.	80-300 Ft-lbs.
<b>Wils-Tronic™ Kits</b>			
	3ø 230V, 60 Hz	<b>46000-0000</b>	<b>46500-0000</b>
Consisting of: Base Control, Foot Switch	3ø 230V, 50 Hz	<b>46005-0000</b>	<b>47005-0000</b>
Power Cable, Motor Mount, Accessory Tool Kit,	3ø 440V, 60 Hz	<b>46040-0000</b>	<b>47040-0000</b>
Telescopic Shaft, Shipping Crate, & Manual	3ø 440V, 50 Hz	<b>46045-0000</b>	<b>47045-0000</b>
<b>Accessories</b>			
Mobile Stand		<b>46000-5400</b>	
Stationary Stand		<b>46000-5010</b>	
3/8-Inch Quick Connector	<b>46000-4200</b>		—
1/2-Inch Quick Connector	<b>46000-4250</b>		<b>21489-0500</b>
3/4-Inch Quick Connector	—		<b>21489-0750</b>
3/4-Inch Extension Coupling	—		<b>46500-4400</b>
1-Inch Extension Coupling	—		<b>46500-4500</b>
1/2-Inch Jacobs Chuck	<b>46000-4600</b>		—
#2MT Adaptor	—		<b>46500-6000</b>
Telescopic Shaft	<b>46000-4000</b>		<b>46500-4000</b>
Service Manual	<b>SM-293</b>	<b>SM-287</b>	<b>SM-296</b>



## Electric Tube Rollers: 1/2 to 3-Inch OD Tubes



Series 22488 with CB Expander

### Applications

- Rolling ferrous and nonferrous tubes in boilers, heat exchangers, and other pressure vessels.

### Features

- **Wilson Electric Tube Rollers** are durable, reliable, and easy to use.
- Both the **41238** and **22488** include dead handles for added leverage.
- On-Off and reverse switches are conveniently located on the fixed handle.
- Exceeding their stall points will not damage these rugged machines.
- Wilson offers a complete line for various tube sizes and voltages. See chart below for selection.



The **76189** Electric Rolling Motor rolls tubes to 1½-inch Outer Diameter.



The **41238** Electric Rolling Motor rolls tubes to 2½-inch Outer Diameter.



The **22488** Electric Rolling Motor rolls tubes up to 3-inch Outer Diameter.

Tube OD Inches (mm)	Voltage and Frequency	Motor Part No.	Free Speed rpm	Amps/Wattage	Drive Spindle	Weight	Overall Length Inches (cm)	Service Manual
½ to 1 ½ (12.7-38.1)	110 Volts 60 Hz	<b>76189-0000</b>	500	7 Amps	1/2 Round	6.8 lbs. (3.1 Kg)	14 ¾ (37.5)	SM-123
	220 Volts 50 Hz	<b>76189-0220</b>						
1 to 2 ½ (25.4-63.5)	110 Volts 60 Hz	<b>41238-0000</b>	250	10 Amps 900 Watts	#3 Morse Taper Socket	19 lbs. (8.6 Kg)	18 ½ (47)	SM-133
	220 Volts 50 Hz	<b>22487-0220</b>				22.7 lbs. (10.3 Kg)		
2 to 3 (50.8-76.2)	110 Volts 60 Hz	<b>22488-0000</b>	100	900 Watts	#4 Morse Taper Socket	23 ½ lbs. (10.6 Kg)	16 ¾ (42)	SM-188
	220 Volts 50 Hz	<b>22488-0220</b>						

Connectors	Part No.
For 76189:	
3/8-Inch (9.5mm) Quick Connector	<b>41337-0000</b>
1/2-Inch (12.7mm) Quick Connector	<b>41723-0000</b>
For 41238 & 22487:	
1/2-Inch (12.7mm) Square Socket x 3 M.T.	<b>41237-0000</b>
3/4-Inch (19.1mm) Square Socket x 3 M.T.	<b>20211-0000</b>
1-Inch (25.4mm) Square Socket x 3 M.T.	<b>20497-0000</b>
For 22488:	
3/4-Inch (19.1mm) Square Socket x 4 M.T.	<b>20212-0000</b>
1-Inch (25.4mm) Square Socket x 4 M.T.	<b>20213-0000</b>

Accessories	Part No.
For 76189:	
On/Off, Forward/Reverse Switch	<b>76189-0105</b>
Set of Motor Brushes ( <i>must order 2 sets</i> )	<b>76189-0125</b>
For 41238:	
On/Off, Forward/Reverse Switch	<b>41238-0105</b>
Set of Motor Brushes ( <i>must order 2 sets</i> )	<b>41238-0125</b>
For 22487 & 22488:	
Forward/Reverse Switch	<b>22488-8691</b>
On/Off Switch	<b>22488-0080</b>
Set of Motor Brushes ( <i>must order 2 sets</i> )	<b>22488-0008</b>

# Electronic Torque-Controlled Tube Rollers: 1/2 to 3-Inch OD Tubes



### Applications

- Rolling ferrous and nonferrous tubes in boilers, heat exchangers, condensers, and other pressure vessels with accurate and repeatable torque control.

### Features

- **Wilson Electric Torque-Controlled Tube Rollers** are durable, reliable, and easy to use. In most cases, you are ready to roll tubes in less than 3 minutes.
- The torque control box is adjustable for expanding torque and will automatically reverse the motor when selected torque is reached.
- Control boxes are available in 110V or 220V single-phase supply choices. Motors are on/off reversing and equipped with dead handle that gives operator added leverage and maneuverability.
- The system consists of a range of electric motors and control boxes. See chart below for selection.



Control Box With Motor



Control Box Panel

- Read-out Screen
- Motor Connector
- On/Off Switch



76189



41238



22488

Tube OD Inches (mm)	Voltage and Frequency	Motor Part No.	Free Speed rpm	Amps/Wattage	Control Box Part No.	Control Box Amps
1/2 to 1 1/2 (12.7-38.1)	110 Volts 60 Hz	76189-5000	500	7 Amps	76190-5000	20
	220 Volts 50 Hz	76189-5220			76190-5220	
1 to 2 1/2 (25.4-63.5)	110 Volts 60 Hz	41238-5000	250	10 Amps 900 Watts	76190-5000	
	220 Volts 50 Hz	22487-5220			76190-5220	
2 to 3 (50.8-76.2)	110 Volts 60 Hz	22488-5000	100	900 Watts	76190-5000	
	220 Volts 50 Hz	22488-5220			76190-5220	

Control Box Service Manual: SM-281

## Tube Wall Reducing Tools

### Features

- Relieves Tube Joint Prior to Cutting
- Self-center Design Prevents Damage to Sheet
- Tubes Do Not Need to be Cleaned Prior to Use



Tube OD Inches (mm)	Tube GA	Part No.	Shank	Major Dia.
1/4 (6.4)	18-24	22088-00xx	1/4-Inch Rd.	.238
5/16 (7.9)	18-24	22089-00xx	5/16-Inch Rd.	.300
3/8 (9.5)	16-24	22090-00xx	3/8-Inch Rd.	.359
1/2 (12.7)	16-22	22091-00xx	#2 MT	.484
5/8 (15.9)	12-22	22092-00xx		.609
3/4 (19.1)	12-22	22093-00xx		.734
7/8 (22.2)	12-22	22094-00xx	#3 MT	.859
1 (25.4)	10-22	22095-00xx		.984
1 1/8 (28.6)	16-22	22096-00xx	#4 MT	1.109
1 1/4 (31.8)	10-20	22097-00xx		1.234
1 1/2 (38.1)	10-15	22098-00xx		1.484

## Manual Tube Puller

### Features

- Easy to Use
- Only Hand Wrenches for Insertion and Withdrawal
- Overall Length Held Short to Operate in Tight Places



Tube OD Inches (mm)	Tube Ga	Part No.	Replacement Spear
1/4 (6.4)	18-19	74811-1819	74811-0001
	20-21	74811-2021	74811-0002
3/8 (9.5)	18-19	74812-1819	74812-0001
	20-21	74812-2021	74812-0002
1/2 (12.7)	16-25	74834	74834-0001
5/8 (15.9)	16-25	74535	74535-0001
3/4 (19.1)	16-25	74536	74536-0001
7/8 (22.2)	16-25	74537	74537-0001
1 (25.4)	16-25	74538	74538-0001
1 1/4 (31.8)	16-25	74732	74732-0001

## Tubesheet Hole Brushes

### Features

- Easy to Use
- Can Clean Thick Tubesheets
- Can be Dipped in Water or Solvent for Additional Cleaning Action



Tube OD Inches (mm)	Nylon (6") Part No.	Stainless Steel	
		Length	Part No.
5/8 (15.9)	41040	6	41045-0006
		12	41045-0012
3/4 (19.1)	41041	6	41046-0006
		12	41046-0012
7/8 (22.2)	41042	6	41047-0006
		12	41047-0012
1 (25.4)	41043	6	41048-0006
		12	41048-0012
1 1/8 (28.6)	41044	6	41049-0006
		12	41049-0012

## Tube Knockout/Collapsing Tools

### Features

- Minimizes Tube Removal Costs
- Specifically Designed as a Companion to the Tube Wall Reducing Tool

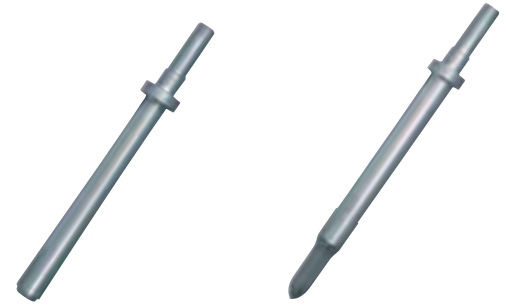

Tube OD Inches (mm)	Tube GA	K.O. Tool Part No.	Shank	OAL	Collapsing Tool No.	OAL	
1/4 (6.4)	18-28	22111-00XX			-	-	
5/16 (7.9)	18-28	22112-00XX			7	-	-
3/8 (9.5)	16-28	21390-00XX			-	-	-
1/2 (12.7)	14-22	20956-00XX	.560/.680 (Round)		9	21909	
5/8 (15.9)	12-22	20957-00XX				21910	11%
3/4 (19.1)	12-22	20958-00XX				21911	
7/8 (22.2)	12-22	20959-00XX				21912	
1 (25.4)	10-22	20960-00XX				21913	11%
1 1/8 (28.6)	16-22	40171-00XX			10		40514
1 1/4 (31.8)	10-22	21391-00XX		21914			
1 1/2 (38.1)	10-22	40563-00XX	.680 (Round)			21915	
2 (50.8)	-	-			-	74010-0800	12%

## Extra Length Tube Knockout Tools



Tube OD Inches (mm)	Tube GA	K.O. Tool Part No.	OAL	K.O. Tool Part No.	OAL
5/8 (15.9)	8-16	20732-00xx	8	20732-14xx	14
3/4 (19.1)	8-16	20733-00xx		20733-14xx	
7/8 (22.2)	8-16	20734-00xx		20734-14xx	
1 (25.4)	8-16	20735-00xx		20735-14xx	
1 1/4 (31.8)	8-16	20736-00xx		20736-14xx	

## Tube Knockout Tools For Use with No. 80 Boyer Gun



Tube OD Inches (mm)	K.O. Tool Part No.	OAL
1 (25.4)	73750	11
1 1/4 (31.8)	72626	8
1 1/2 (38.1)	72806	10
2 (50.8)	72230	
	72940	12



## Tube End Facing Tools - Fixed Type: 1/4 to 9/16-Inch OD Tubes



### Features

- Adjustable Collar provides Projection Control
- Four Flute High Speed Steel
- Simple Replacement of Pilots



Tube OD		Tube GA	Assembly With Collar	Spare Cutter Bits	Shank Dia.
Inches	(mm)				
1/4	(6.4)	18-25	44070-X0GA	44070-0003	1/4-Inch
3/8	(9.5)	18-25	44071-X0GA	44071-0003	
7/16	(11.2)	18-25	44072-X0GA	44072-0003	
1/2	(12.7)	16-25	44073-X0GA	44073-0003	
9/16	(14.3)	16-25	44074-X0GA	44074-0003	

GA = Tube Gauge

## Insert Type: 5/8 to 2-Inch OD Tubes



### Features

- Adjustable Collar provides Projection Control
- Cutter Bits Can Easily be Replaced Lengthening the Life of the Product
- Delrin Pilots are available for 5/8-Inch and larger Tools for Non-Scoring Applications



Tube OD		Tube GA	Assembly With Collar	Spare Cutter Bits	Shank Dia.
Inches	(mm)				
5/8	(15.9)	15-25	44075-X0GA	44075-X001	3/8-Inch
3/4	(19.1)	13-25	44076-X0GA	44076-X001	
7/8	(22.2)	10-25	44077-X0GA	44077-X001	
1	(25.4)	9-25	44078-X0GA	44078-X001	1/2-Inch
1 1/8	(28.6)	15-22	44079-X0GA	44079-X001	
1 1/4	(31.8)	9-14	44080-X0GA	44080-X001	
1 1/2	(38.1)	9-12	44081-X0GA	44081-X001	
1 3/4	(44.5)	9-13	44082-X0GA	44082-X001	
2	(50.8)	7-12	44083-X0GA	44083-X001	

GA = Tube Gauge

X: 0 = Regular Bit; 9 = Coated Bit

Delrin Pilot are available upon request

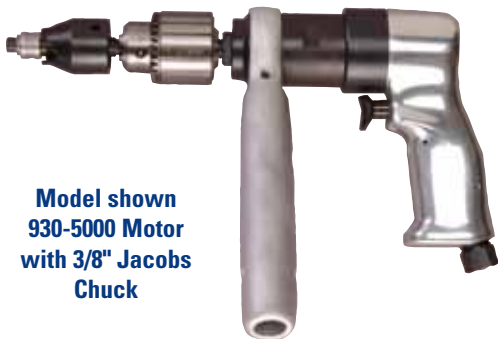

Model shown  
930-5000 Motor  
with 3/8" Jacobs  
Chuck

### TUBE WALL THICKNESS OF WALL IN BIRMINGHAM WIRE GAUGE

GA	28	27	26	25	24	23	22	21	20	19	18	17	16	15	14	13	12	11	10	9	8	7	6
Inch	.014	.016	.018	.020	.022	.025	.028	.032	.035	.042	.049	.058	.065	.072	.083	.095	.109	.120	.134	.148	.165	.180	.203
mm	.4	.4	.5	.5	.6	.6	.7	.8	.9	1.1	1.2	1.5	1.7	1.8	2.1	2.4	2.8	3.0	3.4	3.8	4.2	4.6	5.2

# VLD Vacuum Leak Detector™

## Pin Point Leaky Tubes - 1/4 to 3-Inch OD



### Applications

The Vacuum Leak Detector™ (VLD) is a simple test instrument used by manufacturers and users of condensers, heat exchangers and other tubular apparatus to identify leaky tubes. One man does the job. He seals the far end of each tube with a snap type tube plug, then he presses the rubber coated nozzle into the near end of the tube and depresses the trigger. Compressed air flows through a venturi chamber to produce a vacuum in the tested tube. When this vacuum reaches a satisfactory level, he releases the trigger. A steady Gauge reading indicates a good tube. A falling vacuum indicates a leaky tube. Using a 90 PSI dry clean air, a typical tube (1-inch Outer Diameter x 20 Gauge and 20-feet long) can be tested in 6 to 8 seconds. Tool weighs 2½ lbs. and is equipped with a muffler, so it operates quietly even in confined areas.



Kit No. 9836 for 5/8 to 1½-Inch OD Tubes Consists of	Part No.
Vacuum Leak Detector™	42823
Assembled with Nozzle	41460-1003
Hose Assembly 12-Foot	24360-0012
T-Handle Tube Plug	42834-1003
Carrying Case	42837
Service Manual	SM-158

## Accessory Parts for 'VLD' Tool



Tube Plug Snap Type ID		
Inches	(mm)	Part No.
3/8	(9.5)	41482
7/16	(11.1)	41483
1/2	(12.7)	41484
9/16	(14.3)	41485
5/8	(15.9)	41486
11/16	(17.5)	41487
3/4	(19.1)	41488
13/16	(20.6)	41489
7/8	(22.2)	41490
15/16	(23.8)	41491
31/32	(24.6)	41492
1	(25.4)	41493
1 1/8	(28.6)	41494
1 1/4	(31.8)	41495
1 1/2	(34.9)	41496
1 3/4	(38.1)	41497
1 7/8	(41.3)	41498
1 5/8	(44.5)	41499
1 3/4	(47.6)	41500
2	(50.8)	41501



Additional Nozzles* Available	Part No.
Nozzle for 1/4 to 3/4-Inch OD Tubes	41460-1002
Nozzle for 5/8 to 1½-Inch OD Tubes	41460-1003
Nozzle for 1 1/8 to 2-Inch OD Tubes	41460-1004
Nozzle for 1 1/2 to 3-Inch OD Tubes	41460-1005

\*To be ordered in pairs (2) when T-Handle is used.



Nozzle Extensions:	Part No.
For 5/8 to 1½-Inch Tubes 12-Inch Lg	41461-3012
For 1 1/8 to 2-Inch Tubes 12-Inch Lg	41461-0012
For 1 1/2 to 2-Inch Tubes 24-Inch Lg	41461-0024

## One Piece Tube Plugs - Condensers - Heat Exchangers - Boilers

**Wilson Tube Plugs** offer a low-cost, quick, and efficient method of sealing leaking tubes. They are installed easily, so the pressure vessel get back on line. Minimum driving is required to establish a positive seal in seconds.

The tube plug and tube metal should always match. Fiber plugs require minimal driving since they tighten as they come in contact with water, but *fiber plugs should not be subjected to temperatures exceeding 105°C (221°F)*

- Brass
- Carbon Steel
- Stainless Steel
- Fiber
- Monel (made to order)\*
- Custom Sizes and Materials (We can make tube plugs from any material in any size. Contact us with your requirements.)

Tube plugs are packaged 10 per box, except 1½-inch Outer Diameter or larger plugs which are packaged individually.

Tube		Wall GA	Fiber Part No.	Brass Part No.	Carbon Steel (SA 105) Part No.	Stainless Steel (316) Part No.	Monel* Part No.
OD Inches	(mm)						
3/8	(9.5)	17-22	22017	22023	22029	22041	22035
		11-14					
1/2	(12.7)	15-22	22018	22024	22030	22042	22036
		11-14					
5/8	(15.9)	15-22	22019	22025	22031	22043	22037
		11-14					
3/4	(19.1)	15-22	22020	22026	22032	22044	22038
		11-14					
7/8	(22.2)	15-22	22021	22027	22033	22045	22039
		11-14					
1	(25.4)	15-22	22022	39709	39710	39712	39711
			22028	40506	40507	40508	41581
1 1/8	(31.8)	15-22	44063	41083	42163	41084	-
1 1/4	(34.9)		-	41085	42164	41086	-
1 1/2	(38.1)	10-13	-	41233	42162	41235	-
2	(50.8)		-	-	42600	-	-
2 1/2	(63.5)	-	-	42601	-	-	-
3	(76.2)	-	-	42602	-	-	-

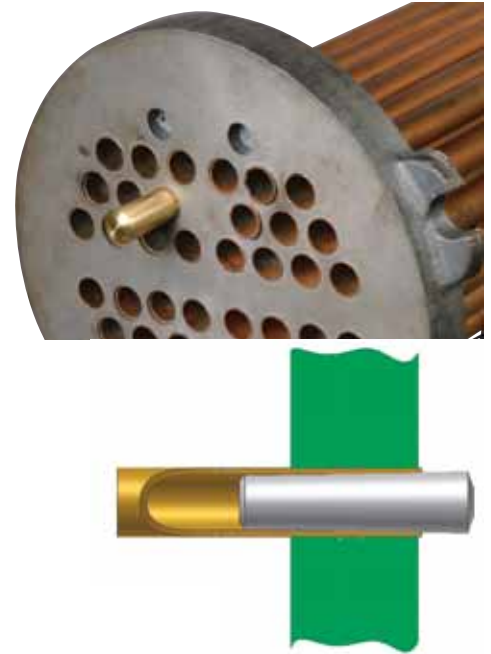

## Two Piece Tube Plugs - Condensers - Heat Exchangers

Tube		Wall GA	Ring & Pin Set Brass Part No.	Tube		Wall GA	Ring & Pin Set Brass Part No.
OD Inches	(mm)			OD Inches	(mm)		
5/8	(15.9)	13	22321-9445	7/8	(22.2)	12	22321-9622
		14	22321-9469			13	22321-9696
		15	22321-9491			14	22321-9719
		16	22321-9505			15	22321-9741
		17	22321-9519			16	22321-9755
		18	22321-9537			17	22321-9769
		19-20	22321-9551			18	22321-9787
3/4	(19.1)	21-22	22321-9571	1	(24.5)	19-20	22321-9801
		12	22321-9537			21-22	22321-9821
		13	22321-9571			12	22321-9787
		14	22321-9594			13	22321-9821
		15	22321-9616			14	22321-9844
		16	22321-9630			15	22321-9866
		17	22321-9644			16	22321-9880
18	22321-9662	17	22321-9894				
19-20	22321-9676	18	22321-9912				
21-22	22321-9696	19-20	22321-9926				
				21-22	22321-9946		



### How to use the tube plug

- For sealing off leaky condenser and heat exchanger tubes without damaging tubesheets. place correct size ring in tube. (Order by Tube Outer Diameter and Gauge)
- Tapered plug is driven into ring, which is tapered on the inside and is parallel to tube on the outside. This gives even expansion to the ring and a long contact to the seal. Available in a variety of metals: stainless steel 316 or 304, carbon steel, and others.



# Wilson Combination Beading Expander

## Applications

- Expand and Bead 2, 2½, and 3-Inch Tubes in One Operation
- For the Fabrication and Re-tubing of Fire Tube Boilers

## Features

- Turn three operations (expanding, beading, and re-rolling) into one. Time-saving, labor-reducing process performed by just one tool!
- Cut labor costs by 50 to 65%!
- Purchase and maintain one tool instead of three.
- Minimal employee training or experience required.
- Produce a perfect, tight bead every time!
- Eliminate all noise for beading operation.

The **Wilson Combination Beading Expander** is one of our smartest tools! Rather than expand a tube, then manually bead it, and then re-roll it with a straight roll expander, the patented **Combination Beading Expander (CBE)** from Thomas C. Wilson, Inc. does all three jobs in one seamless process.

And, the **Wilson CBE** doesn't just save time, cut labor costs, and reduce your equipment investment: *it produces a perfect bead every time!* Designed primarily for the fabrication and re-tubing of fire tube boilers, the **Combination Beading Expander** rolls and beads 2-inch, 2½-inch and 3-inch Outer Diameter tubes, 10 to 13 Gauge.



Combination Beading Expander in use with 909 Right Angle Pneumatic Tube Roller

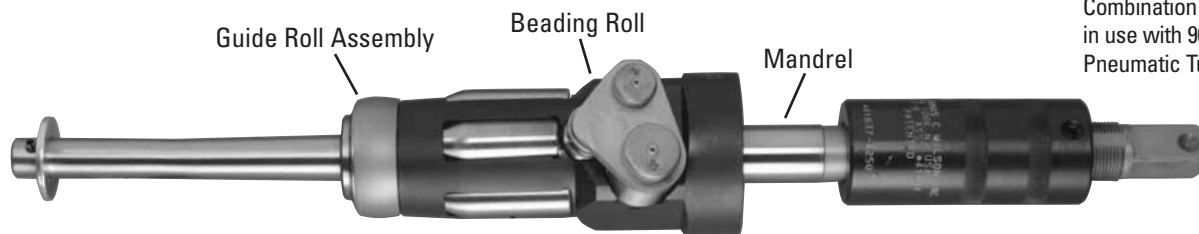

Tube		Beading Expander Assembly*	Mandrel† Part No.	Square	Rolls Before 7/02 Part No.	Rolls for Serialized Expanders	Beading Roll Part No.	Guide Roll Assembly	Expansion Range Inches (mm)
OD Inches	GA (mm)								
2	(50.8)	10	42157	3/4 (19.1)	42811 Set of 4	41677 Set of 4	41631-0010	41701-0010 41701-0011 41701-0012 41701-0013	1.700-1.906 (43.2-48.4)
		11							
		12							
		13							
2½	(63.5)	10	42158	41673 Set of 5	41678 Set of 5	41651-0010 41651-0012	41702-0010 41702-0011 41702-0012 41702-0013	2.200-2.440 (55.9-62.0)	
		11							
		12							
		13							
3	(76.2)	10	42159	41676 Set of 5	41679 Set of 5	41666-0010 41651-0010	41703-0010 41703-0011 41703-0012	2.700-2.940 (68.6-74.7)	
		11							
		12							

\* Assembly includes standard mandrel, grease gun (Part No. 53553) and service manual/parts list (SM-140).

† Short Series Mandrels for wet back or tight turnaround are available.

## Boiler Tube Expanders

### Series 38 Expander



#### Features

- 1-Inch (25.4) up to 1¼ -Inch (44.5)
- Self-feeding
- Flaring style
- Available for tubesheets 1/2-Inch (12.7) to 2½-Inch (66.7)
- Various mandrel lengths available

### Series 114 Expander



#### Features

- 2-Inch (50.8) up to 4½-Inch (114.3)
- Self-feeding
- 2 flare rolls - 4 rolls
- Available for tubesheets 1/2-Inch (12.7) to 2½-Inch (66.7)
- Various Mandrel lengths available

### Series 116 Expander



#### Features

- Four-roll
- Two-flare
- Self-feeding
- Up to 3/4-Inch tubesheet
- Non-parallel expansion

## Series 909 Right-Angle Tube Rollers: 1 to 4-Inch OD Tubes



Series 909-1700/with 114 Flare Expander

### Applications

- Rolling ferrous and nonferrous tubes in water and fire tube boilers and other pressure vessels.
- Ideal for hard-to-reach and confined spaces.

### Features

- Lightweight
- Reversible – stall type
- Heavy-duty gear system
- Right-angle design gives users built-in leverage
- Powerful motor
- 3/4-Inch square spindle

### Kit Includes:

- Right-Angle Tube Roller
- Quick Connector (3/4-Inch square) 21137-0756
- Operating Hose 8973-0008
- Inline Lubricator 53360
- Carrying Case 44099
- Service Manual SM-156 (909-1600, 1700), SM-253 (909-1900)



Series 909-1600, 1700



Series 909-1900



Tube OD Inches (mm)	Free Speed rpm	Tube Roller Part No.	Max Torque @90psiG Air Press. Ft. Lbs. NM	Min Torque @90psiG Air Press. Ft. Lbs. NM	Lever and Controls	Weight	Air Consumption CFM	Service Manual
1 to 2½ (25.4-63.5)	160	909-1600	165 224	10 14	Lever Throttle Stall Type	13.3 lbs (6.0 Kg)	72	SM-156
1 to 2½ (25.4-63.5)	95	909-1700	240 326	10 14	Roll Throttle Stall Type	13.3 lbs (6.0 Kg)		
1½ to 4 (38.1-101.6)	90	909-1900	305 414	150 214	Roll Throttle Stall Type	18.5 lbs (8.8 Kg)	90	SM-253
2 to 4 (50.8-101.6)	90	909-2000	305 414	150 214	Lever Throttle Torque Control	18.5 lbs (8.8 Kg)		
2 to 4 (50.8-101.6)	90	909-2100	305 414	150 214	Roll Throttle Torque Control	18.5 lbs (8.8 Kg)		

Tube Outer Diameter capacity varies with tube Gauge and tubesheet thickness.



### Torque Control Dial

The 909 Torque-Controlled Rolling Motor has the ability to control the torque, simply by adjusting this dial ranging from 150 to 305 ft-lb.

### Accessories for 909 rolling motors:

Descriptions	Part No.
Filter-Lubrication Unit (1/2-Inch Coupling)	8597
1-gallon Can (3.8 Liters) of Wilsolube	9047
1/2-Inch Square (12.7 mm) Coupling	53782
1/2-Inch Square (12.7 mm) Quick Connector	21138-0756
3/4-Inch Square (19.1 mm) Coupling	53777
1-Inch Square (25.4 mm) Coupling	53778
1-Inch Square (25.4 mm) Quick Connector	21489-0756



### Boiler Tube Expanders and Accessories Catalog

A comprehensive guide to all the tools you need to tube or re-tube water tube or fire tube boilers. Includes pneumatic and electric tube rollers, tube cutters, beading and collapsing tools, as well as tube plugs and accessories.



### Heat Exchanger Tube Expanders and Accessories Catalog

A comprehensive guide to all the tools you need to tube or re-tube condensers, chillers, absorbers, evaporators, and coolers. Includes pneumatic, electric and electronic tube rollers, tube pullers, tubesheet hole tools, tube cutting tools, micrometers, and tube plugs.



### Tube Cleaners and Accessories Catalog

A detailed guide to the most extensive line of tube cleaning equipment and accessories available anywhere, including electric, pneumatic, and air-driven tube cleaning systems, spiral and expanding brushes, cutter heads and cutter bits, Blo-Guns and Blo-Brushes, and shafts & casings.



**Thomas C. Wilson, Inc.**  
 21-11 44th Avenue  
 Long Island City, New York 11101-5088  
 Telephone: (718) 729-3360  
 Fax: (718) 361-2872  
 Toll Free: (800) 230-2636  
 www.tcwilson.com  
 e-mail: tcwilson@tcwilson.com